

# Operation, Parts

# Electric Airless Sprayers



## 3A6491H

EN

***For portable airless spraying of architectural paints and coatings. For professional use only. Not approved for use in explosive atmospheres or hazardous locations.***

**490/495/595/650/395EU Models:**  
3300 psi (228 bar, 22.8 MPa) Maximum Working Pressure  
See page 3 for additional model information.



## Important Safety Instructions

Read all warnings and instructions in this manual, in related manuals, and on the unit before using the equipment. Be familiar with the controls and the proper usage of the equipment. Save these instructions.

### Related Manuals

Gun – 3A6285 (Contractor PC)

Pump – 334599



t35141a









*Use only genuine Graco replacement parts.  
The use of non-Graco replacement parts may void warranty.*

PROVEN QUALITY. LEADING TECHNOLOGY.

## Contents

<b>Models</b> .....	<b>3</b>
<b>Warnings</b> .....	<b>4</b>
<b>Component Identification</b> .....	<b>8</b>
Stand Models .....	8
Lo-Boy Models .....	9
Hi-Boy Models .....	10
<b>Grounding</b> .....	<b>11</b>
Power Requirements .....	11
Extension Cords .....	11
Pails .....	11
<b>Pressure Relief Procedure</b> .....	<b>12</b>
<b>Setup</b> .....	<b>13</b>
<b>Startup</b> .....	<b>16</b>
<b>Operation</b> .....	<b>18</b>
Spray Tip Installation .....	18
Spray .....	18
Clear Spray Tip Clog .....	19
Cleanup .....	20
Digital Display .....	23
<b>BlueLink™ App</b> .....	<b>25</b>
Enabling or Disabling BlueLink .....	25
<b>Maintenance</b> .....	<b>26</b>
Recycling and Disposal at End of Life .....	26
<b>Troubleshooting</b> .....	<b>27</b>
Mechanical/Fluid Flow .....	27
Electrical .....	30
<b>490/495/395EU Stand Sprayers</b> .....	<b>38</b>
<b>490/495/595 Lo-Boy Sprayers</b> .....	<b>40</b>
<b>650 Lo-Boy Sprayer</b> .....	<b>42</b>
<b>490/495/595/395EU Hi-Boy Sprayers</b> .....	<b>44</b>
<b>650 Hi-Boy Sprayer</b> .....	<b>46</b>
<b>Accessories and Labels</b> .....	<b>48</b>
<b>Control Box</b> .....	<b>50</b>
<b>Battery Replacement</b> .....	<b>52</b>
<b>Wiring Diagrams</b> .....	<b>53</b>
<b>Technical Specifications</b> .....	<b>58</b>
<b>Compliance</b> .....	<b>60</b>
Radio Frequency Approvals .....	60
<b>Graco Standard Warranty</b> .....	<b>61</b>
<b>Graco Information</b> .....	<b>62</b>

## Models

	VAC	Model	Stand 	Lo-Boy 	Hi-Boy 
 Intertek 110474 Certified to CAN/CSA C22.2 No. 68 Conforms to UL 1450	120 USA	Ultra MAX II 490 PC Pro	17E852	17E853	17E854
		Ultimate MX II 490 PC Pro	826243	826244	826245
		Ultra MAX II 495 PC Pro	17E855	17E856	17E857
		Ultimate MX II 495 PC Pro	826246	826247	826248
		Ultra MAX II 595 PC Pro		17E858	17E859
		Ultimate MX II 595 PC Pro		826249	826250
		Ultra Max II 650 PC Pro		19Y129	19Y128
		Ultimate MX II 650 PC Pro		826259	826258
 	230 CEE 7/7	ST MAX II 395 PC Pro	17E864		17E865
		ST MAX II 495 PC Pro	17E871		17E874
		ST MAX II 595 PC Pro			17E876
	230 Europe Multi	ST MAX II 495 PC Pro	17E872		17E875
		ST MAX II 595 PC Pro			17E877
		Ultra Max II 650 PC Pro		19Y361	19Y359
	110 UK	ST MAX II 495 PC Pro	17E873		17E870
		ST MAX II 595 PC Pro			17E878
Ultra Max II 650 PC Pro			19Y362	19Y360	
	230 Asia/ANZ	Ultra MAX II 490 PC Pro	17E887		
		Ultra MAX II 495 PC Pro	17E889	17E891	17E892
		Ultra MAX II 595 PC Pro		17E897	17E896
		Ultra Max II 650 PC Pro			19Y424
	230 AP	Ultra MAX II 490 PC Pro	26C970		
		Ultra MAX II 495 PC Pro	26C974		
		Ultra MAX II 595 PC Pro		26C977	26C976
	230 AP Multi Cord	Ultra Max II 650 PC Pro		26C979	19Y424
100 JP/TW	Ultra MAX II 490 PC Pro	26C971			
	Ultra MAX II 495 PC Pro	26C975			
	Ultra MAX II 595 PC Pro			26C978	
	Ultra Max II 650 PC Pro			26C980	

## Warnings

The following warnings are for the setup, use, grounding, maintenance, and repair of this equipment. The exclamation point symbol alerts you to a general warning and the hazard symbols refer to procedure-specific risks. When these symbols appear in the body of this manual or on warning labels, refer back to these Warnings. Product-specific hazard symbols and warnings not covered in this section may appear throughout the body of this manual where applicable.

### **WARNING**



#### **GROUNDING**

This product must be grounded. In the event of an electrical short circuit, grounding reduces the risk of electric shock by providing an escape wire for the electric current. This product is equipped with a cord having a grounding wire with an appropriate grounding plug. The plug must be plugged into an outlet that is properly installed and grounded in accordance with all local codes and regulations.

- Improper installation of the grounding plug is able to result in a risk of electric shock.
- When repair or replacement of the cord or plug is required, do not connect the grounding wire to either flat blade terminal.
- The wire with insulation having an outer surface that is green with or without yellow stripes is the grounding wire.
- Check with a qualified electrician or serviceman when the grounding instructions are not completely understood, or when in doubt as to whether the product is properly grounded.
- Do not modify the plug provided; if it does not fit the outlet, have the proper outlet installed by a qualified electrician.
- This product is for use on a nominal 120 V or 230 V circuit and has a grounding plug similar to the plugs illustrated in the figure below.

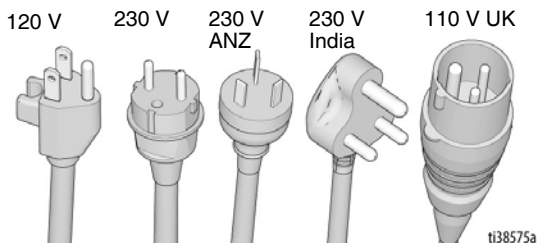

- Only connect the product to an outlet having the same configuration as the plug.
- Do not use a 3-to-2 adapter with this product.

#### Extension Cords:

- Use only a 3-wire extension cord that has a grounding plug and a grounding receptacle that accepts the plug on the product.
- Make sure your extension cord is not damaged. If an extension cord is necessary, use 12 AWG (2.5 mm<sup>2</sup>) minimum to carry the current that the product draws.
- An undersized cord results in a drop in line voltage and loss of power and overheating.



**WARNING**
**FIRE AND EXPLOSION HAZARD**

Flammable fumes, such as solvent and paint fumes, in work area can ignite or explode. To help prevent fire and explosion:

- Do not spray flammable or combustible materials near an open flame or sources of ignition such as cigarettes, motors, and electrical equipment.
- Paint or solvent flowing through the equipment is able to result in static electricity. Static electricity creates a risk of fire or explosion in the presence of paint or solvent fumes. All parts of the spray system, including the pump, hose assembly, spray gun, and objects in and around the spray area shall be properly grounded to protect against static discharge and sparks. Use Graco conductive or grounded high-pressure airless paint sprayer hoses.
- Verify that all containers and collection systems are grounded to prevent static discharge. Do not use pail liners unless they are anti-static or conductive.
- Connect to a grounded outlet and use grounded extensions cords. Do not use a 3-to-2 adapter.
- Do not use a paint or a solvent containing halogenated hydrocarbons.
- Do not spray flammable or combustible liquids in a confined area.
- Keep spray area well-ventilated. Keep a good supply of fresh air moving through the area.
- Sprayer generates sparks. Keep pump assembly in a well-ventilated area at least 20 feet (6.1 m) from the spray area when spraying, flushing, cleaning, or servicing. Do not spray pump assembly.
- Do not smoke in the spray area or spray where sparks or flame is present.
- Do not operate light switches, engines, or similar spark producing products in the spray area.
- Keep area clean and free of paint or solvent containers, rags, and other flammable materials.
- Know the contents of the paints and solvents being sprayed. Read all Safety Data Sheets (SDSs) and container labels provided with the paints and solvents. Follow the paint and solvent manufacturer's safety instructions.
- Keep a working fire extinguisher in the work area.

## **WARNING**



### **SKIN INJECTION HAZARD**

High-pressure spray is able to inject toxins into the body and cause serious bodily injury. In the event that injection occurs, **get immediate surgical treatment**.



- Do not aim the gun at, or spray any person or animal.
- Keep hands and other body parts away from the discharge. For example, do not try to stop leaks with any part of the body.



- Always use the nozzle tip guard. Do not spray without nozzle tip guard in place.
- Use Graco nozzle tips.



- Use caution when cleaning and changing nozzle tips. In the case where the nozzle tip clogs while spraying, follow the **Pressure Relief Procedure** for turning off the unit and relieving the pressure before removing the nozzle tip to clean.



- Equipment maintains pressure after power is shut off. Do not leave the equipment energized or under pressure while unattended. Follow the **Pressure Relief Procedure** when the equipment is unattended or not in use, and before servicing, cleaning, or removing parts.

- Check hoses and parts for signs of damage. Replace any damaged hoses or parts.
- This system is capable of producing 3300 psi. Use Graco replacement parts or accessories that are rated a minimum of 3300 psi.
- Always engage the trigger lock when not spraying. Verify the trigger lock is functioning properly.
- Verify that all connections are secure before operating the unit.
- Know how to stop the unit and bleed pressure quickly. Be thoroughly familiar with the controls.









### **EQUIPMENT MISUSE HAZARD**

Misuse can cause death or serious injury.



- Always wear appropriate gloves, eye protection, and a respirator or mask when painting.
- Do not operate or spray near children. Keep children away from equipment at all times.
- Do not overreach or stand on an unstable support. Keep effective footing and balance at all times.
- Stay alert and watch what you are doing.
- Do not operate the unit when fatigued or under the influence of drugs or alcohol.
- Do not kink or over-bend the hose.
- Do not expose the hose to temperatures or to pressures in excess of those specified by Graco.
- Do not use the hose as a strength member to pull or lift the equipment.
- Do not spray with a hose shorter than 25 feet.
- Do not alter or modify equipment. Alterations or modifications may void agency approvals and create safety hazards.
- Make sure all equipment is rated and approved for the environment in which you are using it.

## **WARNING**

 	<p><b>ELECTRIC SHOCK HAZARD</b></p> <p>This equipment must be grounded. Improper grounding, setup, or usage of the system can cause electric shock.</p> <ul style="list-style-type: none"> <li>• Turn off and disconnect power cord before servicing equipment.</li> <li>• Connect only to grounded electrical outlets.</li> <li>• Use only 3-wire extension cords.</li> <li>• Ensure ground prongs are intact on power and extension cords.</li> <li>• Do not expose to rain. Store indoors.</li> <li>• Wait five minutes after disconnecting power cord before servicing.</li> </ul>
	<p><b>PRESSURIZED ALUMINUM PARTS HAZARD</b></p> <p>Use of fluids that are incompatible with aluminum in pressurized equipment can cause serious chemical reaction and equipment rupture. Failure to follow this warning can result in death, serious injury, or property damage.</p> <ul style="list-style-type: none"> <li>• Do not use 1,1,1-trichloroethane, methylene chloride, other halogenated hydrocarbon solvents or fluids containing such solvents.</li> <li>• Do not use chlorine bleach.</li> <li>• Many other fluids may contain chemicals that can react with aluminum. Contact your material supplier for compatibility.</li> </ul>
 	<p><b>MOVING PARTS HAZARD</b></p> <p>Moving parts can pinch, cut or amputate fingers and other body parts.</p> <ul style="list-style-type: none"> <li>• Keep clear of moving parts.</li> <li>• Do not operate equipment with protective guards or covers removed.</li> <li>• Equipment can start without warning. Before checking, moving, or servicing equipment, follow the <b>Pressure Relief Procedure</b> and disconnect all power sources.</li> </ul>
	<p><b>TOXIC FLUID OR FUMES HAZARD</b></p> <p>Toxic fluids or fumes can cause serious injury or death if splashed in the eyes or on skin, inhaled, or swallowed.</p> <ul style="list-style-type: none"> <li>• Read Safety Data Sheets (SDSs) to know the specific hazards of the fluids you are using.</li> <li>• Store hazardous fluid in approved containers, and dispose of it according to applicable guidelines.</li> </ul>
	<p><b>PERSONAL PROTECTIVE EQUIPMENT</b></p> <p>Wear appropriate protective equipment when in the work area to help prevent serious injury, including eye injury, hearing loss, inhalation of toxic fumes, and burns. This protective equipment includes but is not limited to:</p> <ul style="list-style-type: none"> <li>• Protective eyewear, and hearing protection.</li> <li>• Respirators, protective clothing, and gloves as recommended by the fluid and solvent manufacturer.</li> </ul>

# Component Identification

## Component Identification

### Stand Models

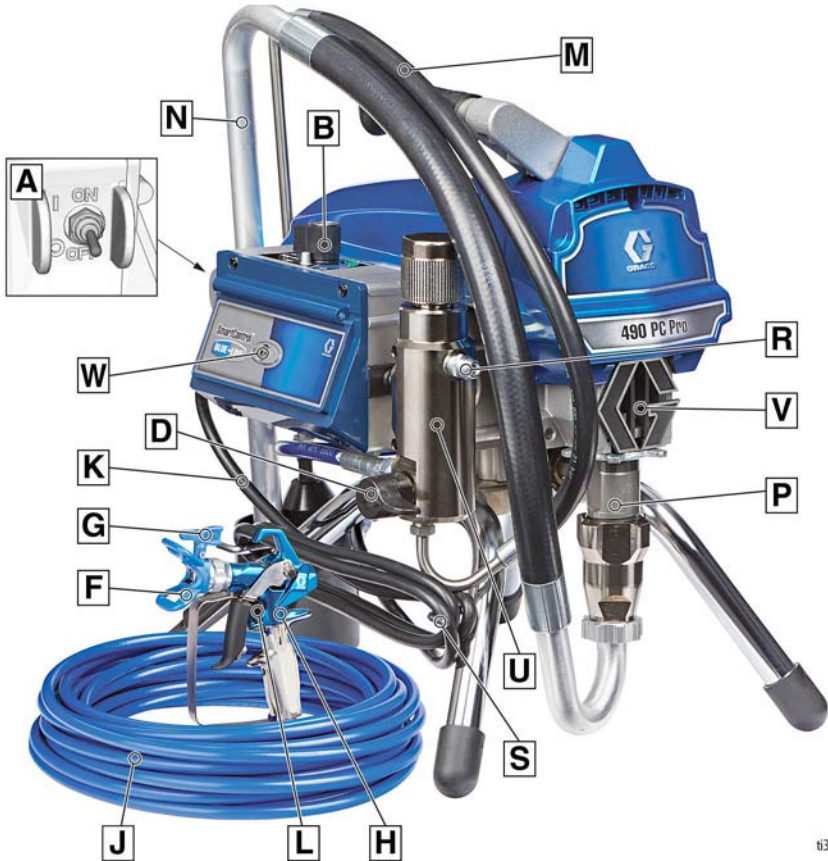

ti35142a

A	ON/OFF Switch
B	Pressure Control
D	Prime Valve
F	Tip Guard
G	Spray Tip
H	Gun
J	Airless Hose
K	Power Cord
L	Trigger Lock
M	Drain Tube

N	Suction Tube
P	Pump
R	Fluid Outlet
S	Power Cord Wrap
U	Filter
V	Finger Guard / TSL Fill Point
W	BlueLink™ Status Light (if applicable)
	Model/Serial Tag (Not shown, located on bottom of unit.)

# Component Identification

## Lo-Boy Models

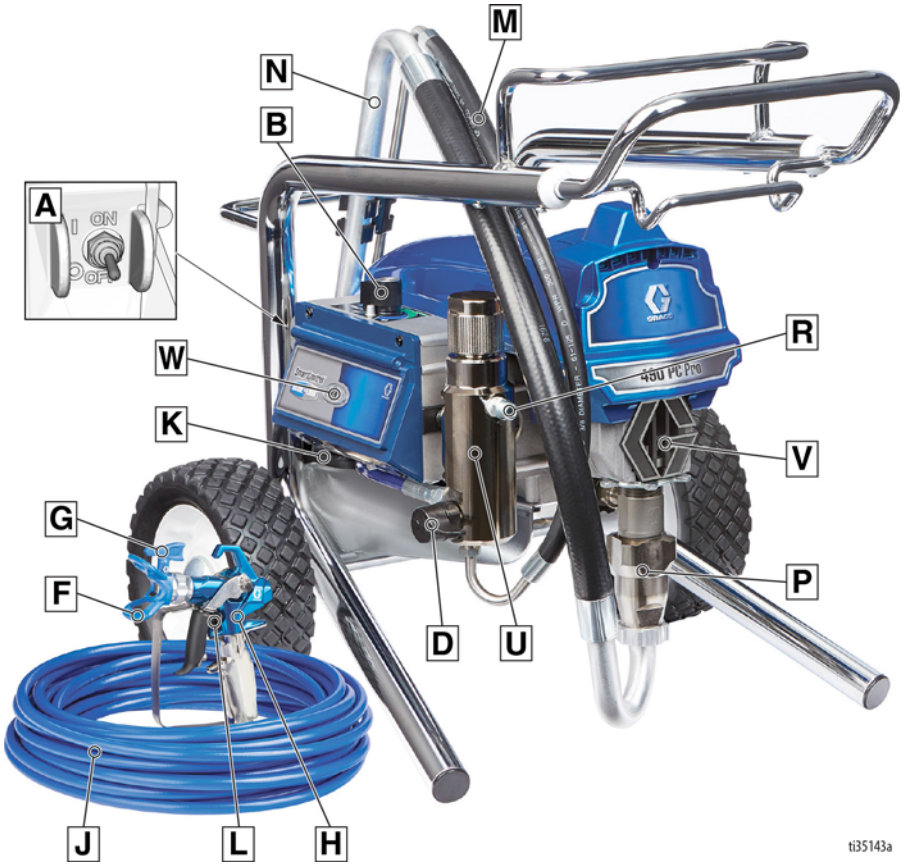

ti35143a

A	ON/OFF Switch
B	Pressure Control
D	Prime Valve
F	Tip Guard
G	Spray Tip
H	Gun
J	Airless Hose
K	Power Cord
L	Trigger Lock

M	Drain Tube
N	Suction Tube
P	Pump
R	Fluid Outlet
U	Filter
V	Finger Guard / TSL Fill Point
W	BlueLink Status Light (if applicable)
	Model/Serial Tag (Not shown, located on bottom of unit.)

# Component Identification

## Hi-Boy Models

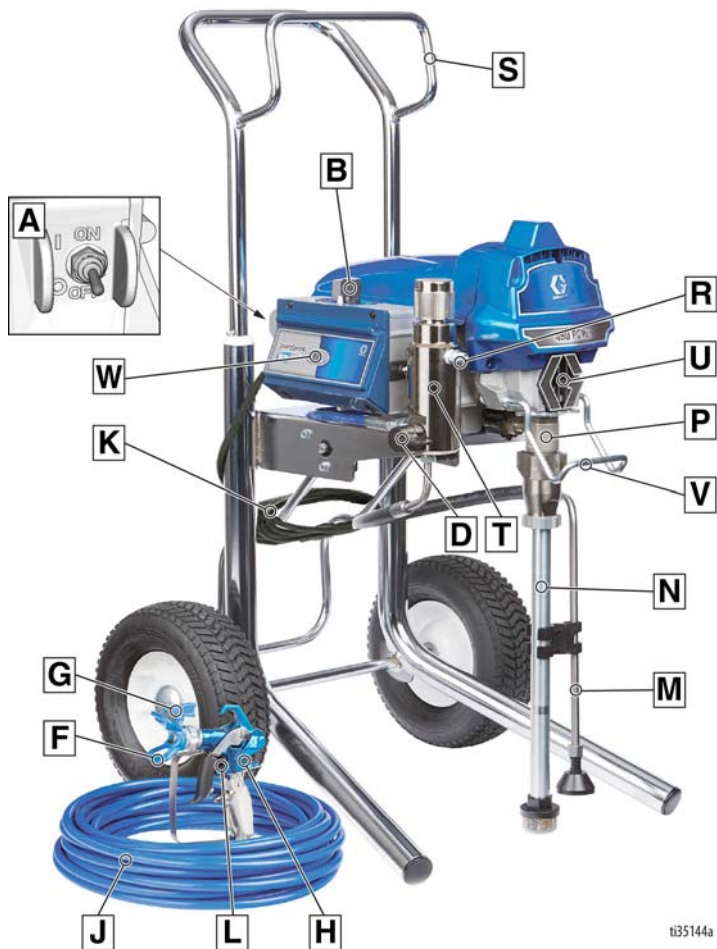

ti35144a

A	ON/OFF Switch
B	Pressure Control
D	Prime Valve
F	Tip Guard
G	Spray Tip
H	Gun
J	Airless Hose
K	Power Cord
L	Trigger Lock
M	Drain Tube
N	Suction Tube

P	Pump
R	Fluid Outlet
S	Hanger
T	Filter
U	Finger Guard / TSL Fill Point
V	Pail Hook
W	BlueLink Status Light (if applicable)
	Model/Serial Tag (Not shown, located on bottom of unit.)

# Grounding



The equipment must be grounded to reduce the risk of static sparking and electric shock. An electric or static spark can cause fumes to ignite or explode. An improper ground can cause electric shock. A good ground provides an escape wire for the electric current.

This sprayer is equipped with a power cord that has a ground wire and an appropriate grounding plug.

The plug must be plugged into an outlet that is properly installed and grounded in accordance with all local codes and ordinances.

Do not modify the plug provided; if it does not fit the outlet, have the proper outlet installed by a qualified electrician.

## Power Requirements

- 100-120V units require 100-120 VAC, 50/60 Hz, 12 or 15A, 1 phase.
- 230V units require 230 VAC, 50/60 HZ, 7 or 9A, 1 phase.

## Extension Cords

Use an extension cord with an undamaged ground contact. If an extension cord is necessary, use a 3-wire, 12 AWG (2.5 mm<sup>2</sup>) minimum.

**NOTE:** Smaller gauge or longer extension cords may reduce sprayer performance.

## Pails

**Solvent and oil-based fluids:** follow local code. Use only conductive metal pails, placed on a grounded surface such as concrete.

Do not place pail on a non-conductive surface such as paper or cardboard which interrupts grounding continuity.

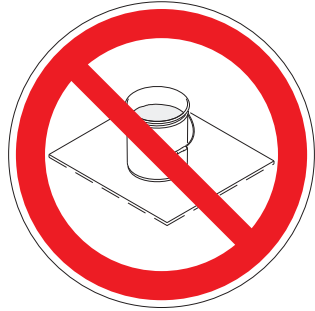

**Always ground a metal pail:** connect a ground wire to the pail. Clamp one end to the pail and the other end to a true earth ground such as a water pipe.

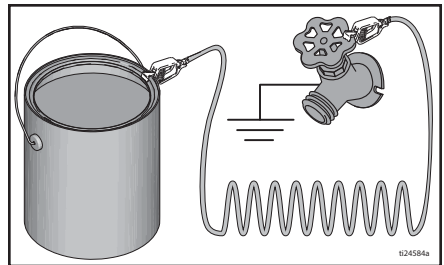

**To maintain ground continuity when sprayer is flushed or pressure is relieved:** hold metal part of spray gun firmly to the side of a grounded metal pail then trigger the gun.

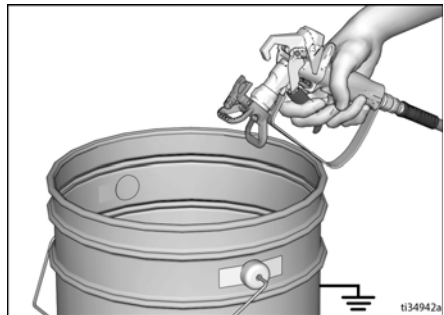



# Pressure Relief Procedure

## Pressure Relief Procedure



Follow the Pressure Relief Procedure whenever you see this symbol.



This equipment stays pressurized until pressure is manually relieved. To help prevent serious injury from pressurized fluid, such as skin injection, splashed fluid and moving parts, follow the Pressure Relief Procedure whenever sprayer is stopped and before sprayer is cleaned or checked, and before equipment is serviced.

1. Turn ON/OFF switch to the **OFF** position.



2. Engage the trigger lock.

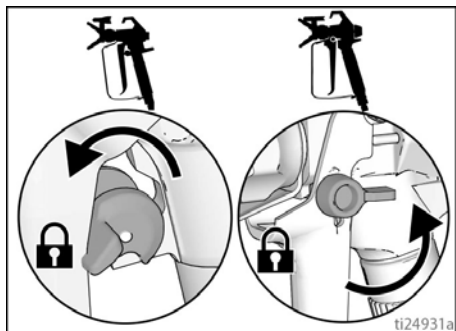

3. Turn pressure control to the lowest setting.

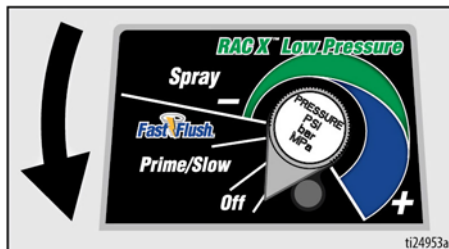

4. Put drain tube in a pail and turn prime valve down to relieve pressure. Leave prime valve in the down (drain) position until you are ready to spray again.

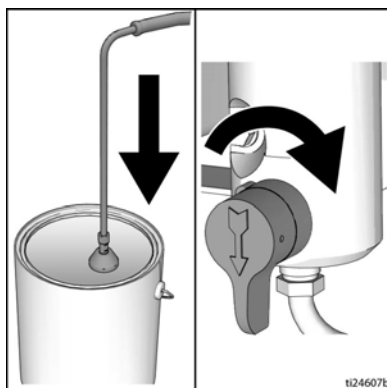

5. Hold a metal part of the spray gun firmly to a grounded metal pail. Point spray gun into pail. Disengage the trigger lock and trigger the spray gun to relieve pressure.





6. Engage the Trigger Lock.
7. If you suspect the spray tip or hose is clogged or that pressure has not been fully relieved:
  - a. **VERY SLOWLY** loosen the tip guard retaining nut or the hose end coupling to relieve pressure gradually.
  - b. Loosen the nut or coupling completely.
  - c. Clear hose or tip obstruction.

## Trigger Lock

Always engage the trigger lock when sprayer is stopped to prevent the gun from being triggered accidentally by hand or if dropped or bumped.

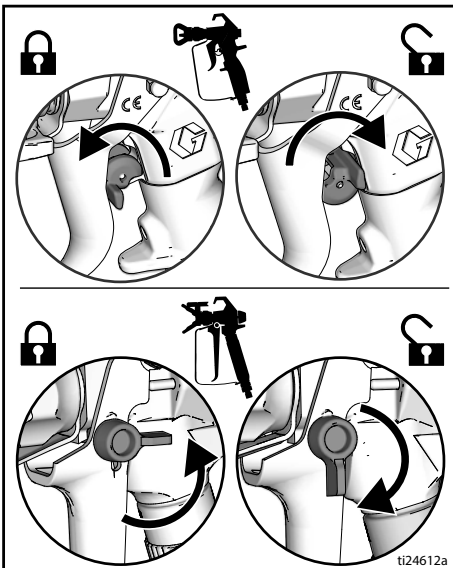

## Setup

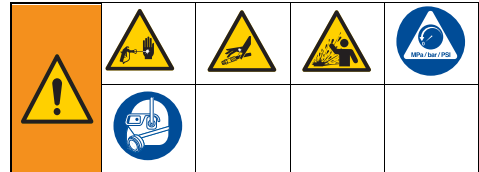

When unpacking sprayer for the first time or after long term storage perform setup procedure. When first setup is performed remove shipping plug from fluid outlet.

1. Connect Graco airless hose to fluid outlet. Use wrenches to tighten securely.

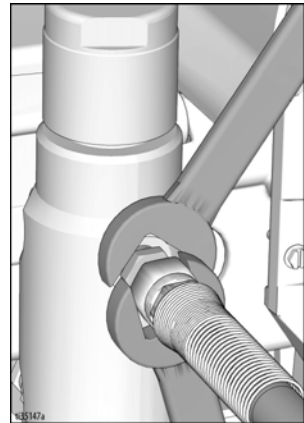

2. Connect other end of hose to gun.

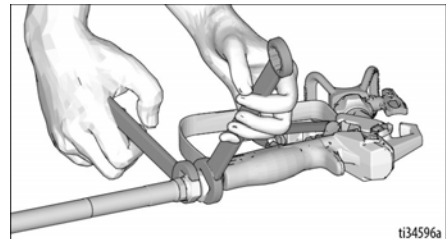

3. Use wrenches to tighten securely.

# Setup

4. Engage trigger lock.

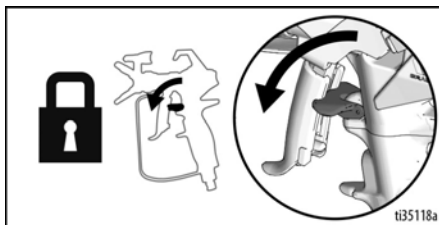

5. Remove tip guard.

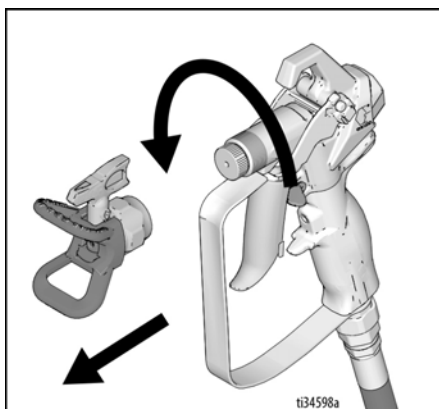

6. When unpacking sprayer for the first time remove packaging materials from inlet strainer. After long term storage check inlet strainer for clogs and debris.

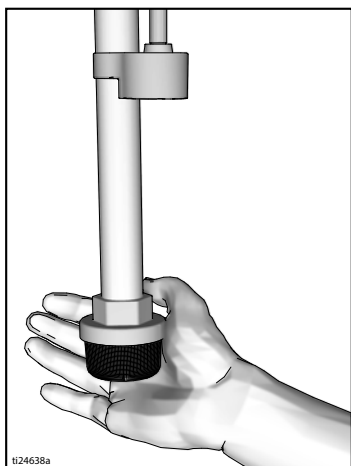

7. Fill throat packing nut with TSL to prevent premature packing wear. Do this daily or each time you spray.

- Place the TSL bottle nozzle into the top center opening in the grill at the front of the sprayer.
- Squeeze bottle to dispense enough TSL to fill the space between the pump rod and packing nut seal.

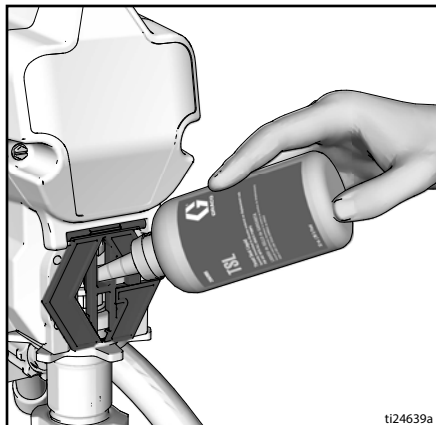

8. Make certain ON/OFF switch is OFF.



9. Plug power supply cord into a properly grounded electrical outlet.

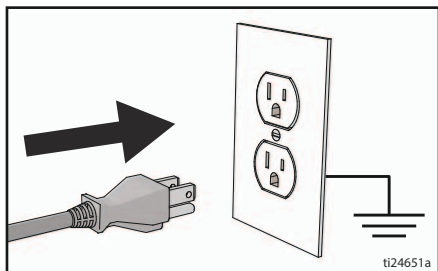

10. Turn prime valve down.

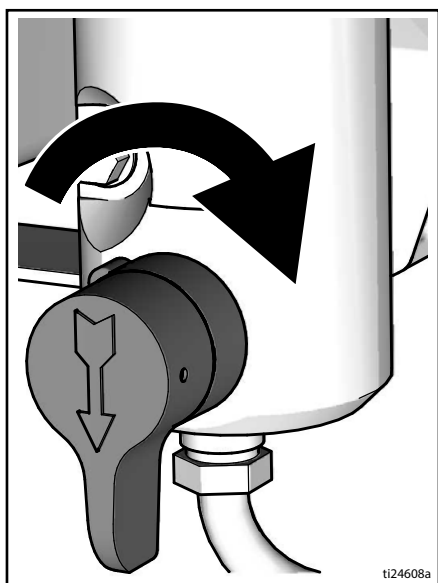

11. Place fluid intake with drain tube in grounded metal pail partially filled with flushing fluid. See **Grounding**, page 11.

**NOTE:** New sprayers are shipped with storage fluid that must be flushed out with mineral spirits prior to using the sprayer.

Check flushing fluid for compatibility with material that is to be sprayed. A secondary flush with a compatible fluid may be necessary. Water for latex paint or mineral spirits for oil-based paint.

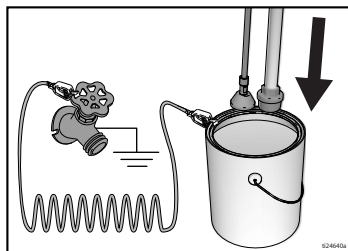

12. Turn pressure control to OFF.
13. Turn ON/OFF switch to **ON** position.
14. Turn prime valve horizontal. Disengage trigger lock.
15. Turn pressure control to Prime/Slow.
16. Hold a metal part of the gun firmly to a grounded metal pail. Trigger gun and flush for one minute.
17. Turn ON/OFF switch to **OFF** position.
18. Engage trigger lock.
19. After flushing storage fluid out of the sprayer empty pail. Replace fluid intake with drain tube in grounded metal pail partially filled with flushing fluid. Use water to flush water-based paint or mineral spirits to flush oil-based paint.
20. Turn ON/OFF switch to **ON** position.
21. Turn prime valve horizontal. Disengage trigger lock.
22. Hold a metal part of the gun firmly to a grounded metal pail. Trigger gun and flush until clean.
23. Turn ON/OFF switch to **OFF** position.
24. Engage trigger lock.
25. Sprayer is now ready for startup and spray.

# Startup

## Startup

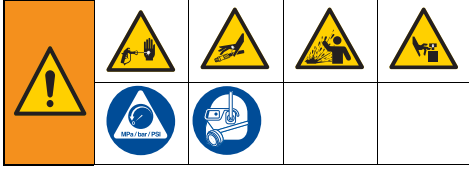

1. Perform **Pressure Relief Procedure**, page 12.
2. Turn pressure control to lowest pressure.



3. Turn ON/OFF switch to **ON** position.



4. Place fluid intake in paint pail. Place drain tube in waste pail.

5. Turn pressure control to Fast Flush to start motor. Allow paint to circulate through drain tube for 15 seconds.



6. Turn prime valve horizontal. Disengage trigger lock.

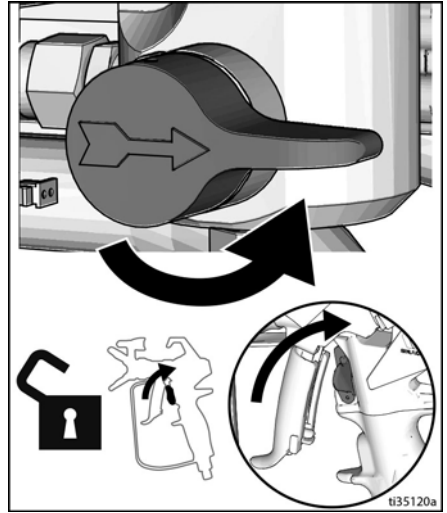

7. Hold gun against grounded metal waste pail. Trigger gun until paint appears.



8. Move gun to paint pail and trigger for 20 seconds. Release trigger and allow sprayer to build pressure. Engage trigger lock.



9. Inspect airless hose connections for leaks. If leaks occur, perform **Pressure Relief Procedure**, page 12, then tighten all fittings and repeat Startup procedure. If there are no leaks continue with the next step.
10. Screw tip assembly onto gun and tighten. See **Spray Tip Installation**, page 18. For gun assembly instructions, see separate gun manual.

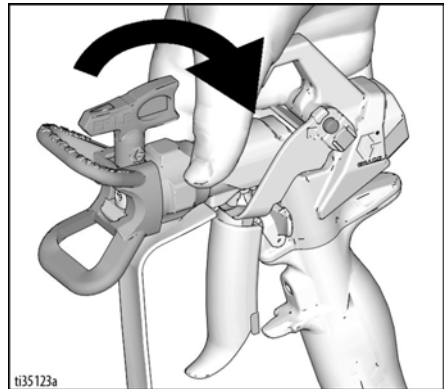

# Operation

## Operation

### Spray Tip Installation



To avoid serious injury from skin injection do not put your hand in front of the spray tip when installing or removing the spray tip and tip guard.

1. Perform **Pressure Relief Procedure**, page 12.
2. Use spray tip (A) to insert OneSeal™ (B) into tip guard (C).

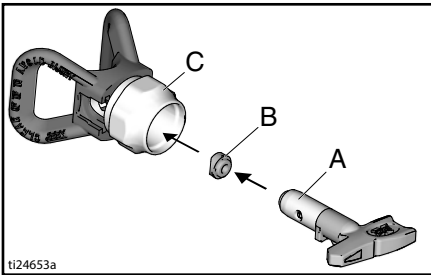

3. Insert Spray Tip.

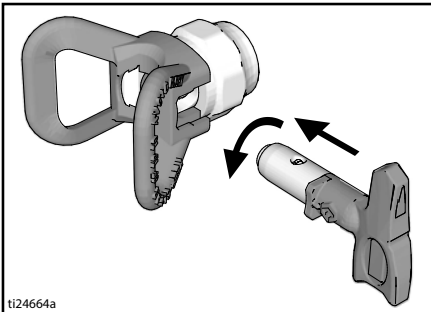

4. Screw assembly onto gun. Tighten.

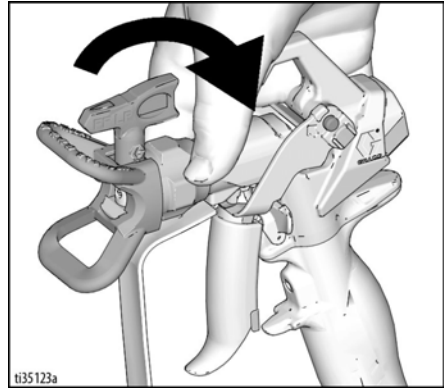

### Spray

When a RAC X™ FF LP Fine Finish Low Pressure reversible spray tip is used, spraying pressure can be lowered. Spraying at a lower pressure results in less over spray and reduces spray tip wear. Adjust the sprayer pressure to minimize overspray.

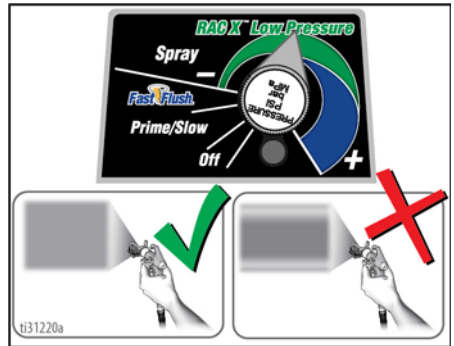

Atomized, evenly distributed fan pattern

Tails

1. Spray test pattern. Adjust pressure to eliminate heavy edges.

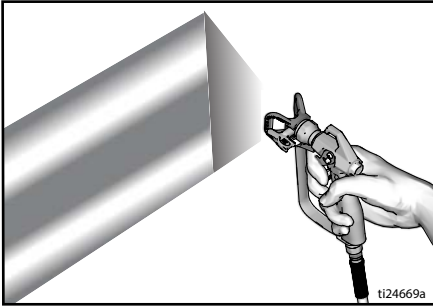

2. Use smaller tip size if pressure adjustment cannot eliminate heavy edges.
3. Hold gun perpendicular, 10-12 in. (25-30 cm) from surface. Spray back and forth; overlap by 50%.

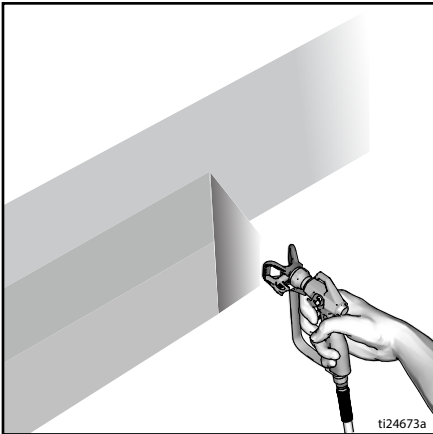

4. Trigger gun after moving. Release trigger before stopping. For additional spraying information, see separate gun manual.

## Clear Spray Tip Clog



1. Release trigger. Engage trigger lock. Rotate Spray Tip. Disengage trigger lock. Trigger gun at waste area to clear clog.



2. Engage trigger lock. Return Spray Tip to original position. Disengage trigger lock and continue spraying.

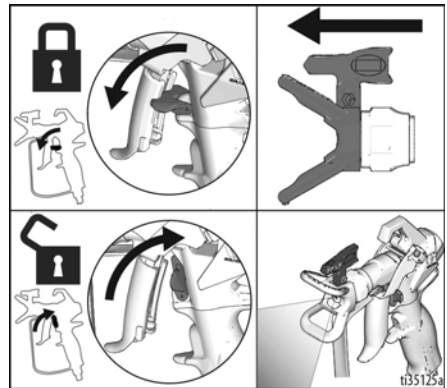

# Operation

## Cleanup

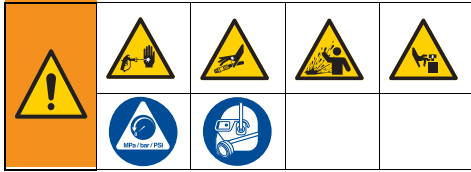

1. Perform **Pressure Relief Procedure**, page 12.
2. Remove tip guard and Spray Tip. For additional information, see separate gun manual.

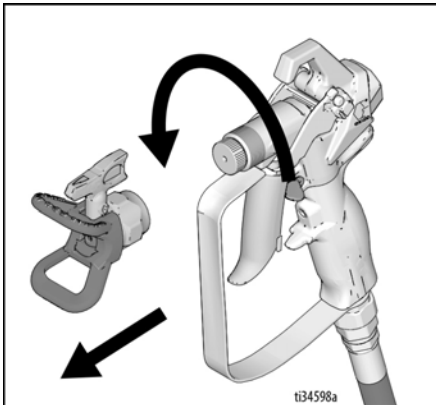

### Fast Flush Drain Tube

3. Remove fluid intake and drain tube from paint, wipe excess paint off outside.

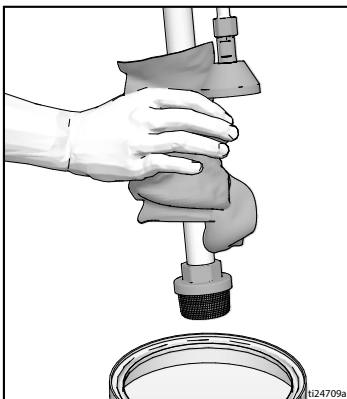

4. Place fluid intake in flushing fluid. Use water for water base paint and mineral spirits for oil-based paint. Place drain tube in waste pail.

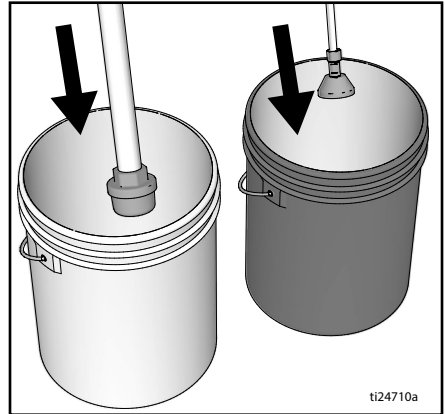

5. To flush drain tube and pump turn prime valve down.

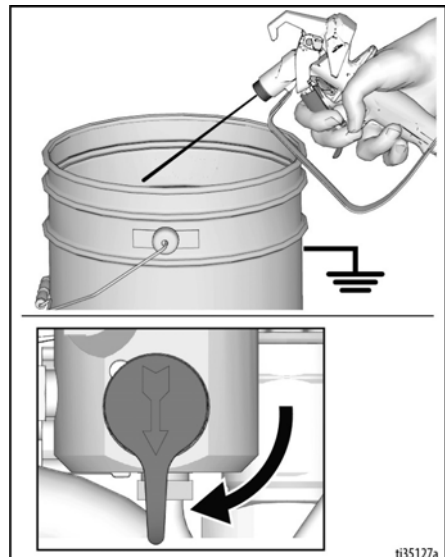

6. Turn pressure control to Fast Flush operate until the pump runs steady and flushing fluid appears in the waste pail.



## Fast Flush Hose and Gun

7. To flush airless hose and spray gun, turn prime valve horizontal.
8. Hold gun against waste pail. Disengage trigger lock. Trigger gun and turn pressure control to Fast Flush operate until the pump runs steady and flushing fluid appears.

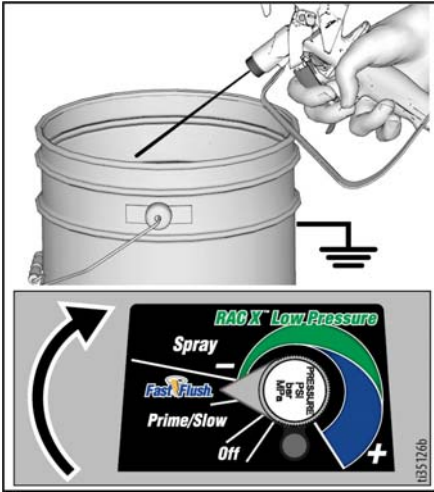

9. Stop triggering gun.

10. Raise fluid intake above flushing fluid.

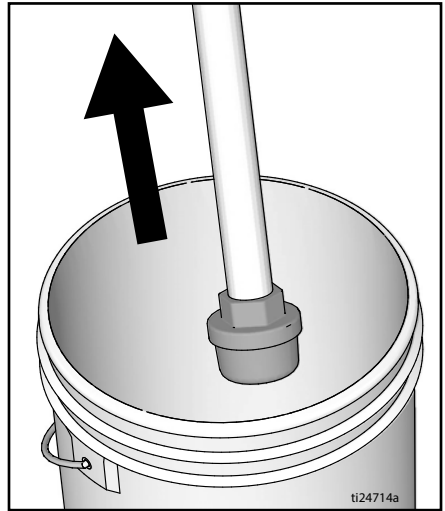

11. With prime valve horizontal. Trigger gun into flushing pail to purge fluid from hose.
12. Engage trigger lock.



# Operation

13. Turn pressure control knob to OFF and turn ON/OFF switch to **OFF** position. Disconnect power to sprayer.

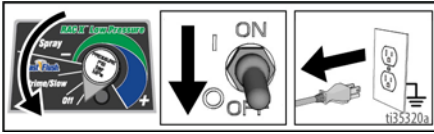

14. Remove filter from gun and sprayer if installed. Clean and inspect. Install filter. See separate gun manual.

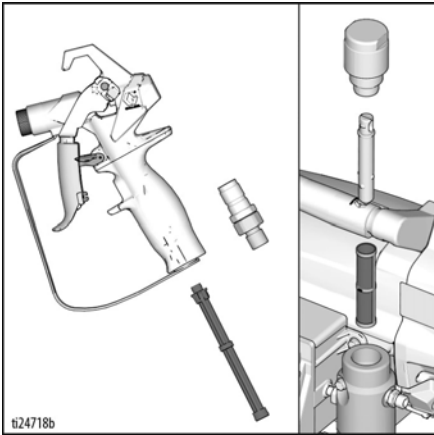

15. If flushing with water, flush again with mineral spirits or Pump Armor to leave a protective coating to prevent freezing or corrosion.

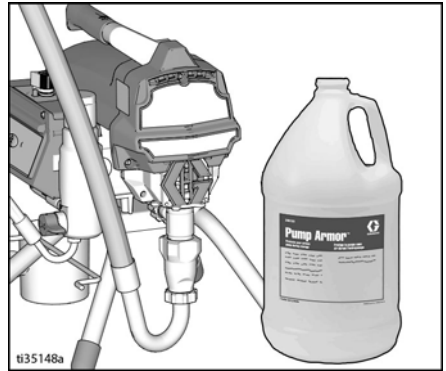

16. Wipe sprayer, hose and gun with a rag soaked in water or mineral spirits.

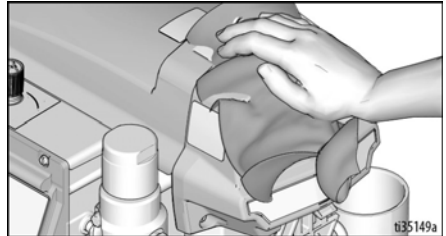

## Digital Display

Most models are equipped with a digital display. This section explains how to use this feature.



## Operation Main Menu

A short press of the display button moves to the next display. Press and hold display button for five seconds to change units or reset data.

1. Perform **Pressure Relief Procedure**, page 12.
2. Plug sprayer into grounded outlet. Turn ON/OFF switch to **ON** position.

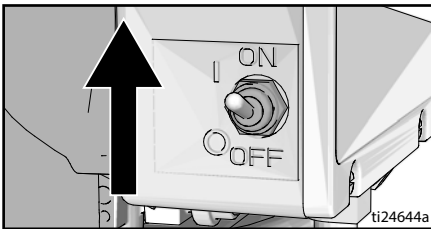
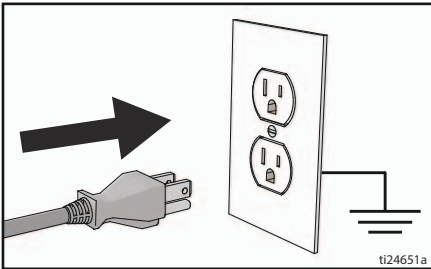

3. Pressure display appears. Dashes appear when pressure is less than 200 psi (14 bar, 1.4 MPa).

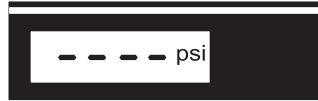

ti2786a

4. Short press display button to move to Job Gallons (or Liters x 10).

**NOTE: JOB** displays briefly, then the number of gallons sprayed above 1000 psi (70 bar, 7MPa).

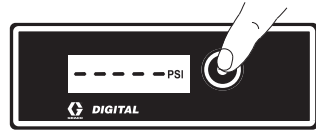

ti7486b

5. Press and hold display button to reset to zero, or short press button to move to Lifetime Gallons (or Liters x10).

**NOTE: LIFE** displays briefly, then the number of gallons sprayed above 1000 psi (70 bar, 7MPa).



ti7487b

6. To change pressure units (psi, bar, or MPa), press and hold display button for eight seconds until desired units appear. Selection of bar or MPa changes gallons to Liters x10.

# Operation

## Stored Data Display

1. Perform **Pressure Relief Procedure**, page 12.
2. Press display button and turn ON/OFF switch to **ON** position.

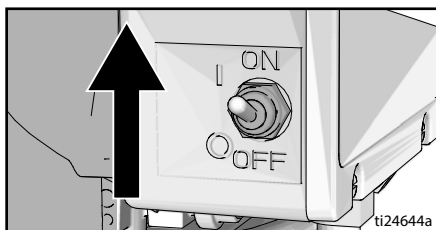

3. **S/N** displays for one second, then the serial number. Short press display button and the total motor run hours is displayed.



ti7489b



4. Short press display button and the last error code is displayed: e.g., **E=07**. See **Electrical**, page 30 for trouble shooting information.



ti7490b

5. Press and hold display button to clear error code to zero. Short press to move to software **REV**.



ti7491b

6. Turn ON/OFF switch to **OFF** position to exit Stored Data.

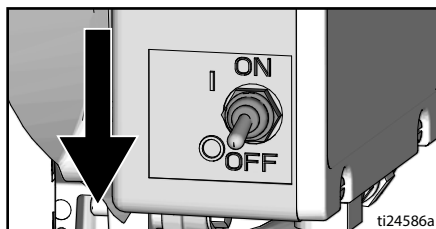

ti24586a

# BlueLink™ App

(If applicable)

Download the Graco BlueLink app from the Apple App Store, Google Play, or other available application stores to connect to the paint sprayer via Bluetooth®.

The BlueLink app allows you to access sprayer information, settings, statistics, and provides access to useful features such as WatchDog™, improved maintenance tracking, sprayer tracking, and job tracking. Find the Graco BlueLink App at:

<https://www.graco.com/BlueLink>



Further instructions can be accessed within the app. Instructions can also be accessed online at:

<https://www.graco.com/BlueLinkSupport>



## Enabling or Disabling BlueLink



The Graco BlueLink system uses Bluetooth to communicate between the sprayer's control board and a mobile phone. To disable BlueLink by shutting off the Bluetooth transmitter, perform the following steps:

1. Turn the ON/OFF switch to the **OFF** position. Turn the Pressure Control Knob all the way counterclockwise to the **OFF** position.
2. Unplug sprayer from power outlet and allow power to dissipate for 5 minutes.
3. Remove control box cover.
4. On the main control board, disconnect the ribbon cable. To enable BlueLink, re-connect this cable.



5. Reassemble control box cover.

## Maintenance

Routine maintenance is important to ensure proper operation of your sprayer.

Maintenance includes performing routine actions which keep your sprayer in operation and prevents trouble in the future.



Perform **Pressure Relief Procedure**, page 12, before performing maintenance.

Activity	Interval
Inspect/clean sprayer filter, fluid inlet strainer, and gun filter.	Daily or each time you spray
Inspect motor shield vents for blockage.	Daily or each time you spray
Fill TSL by adding through TSL fill point.	Daily or each time you spray
Check sprayer stall. With sprayer gun NOT triggered, sprayer motor should stall and not restart until gun is triggered again. If sprayer starts again with gun NOT triggered, inspect pump for internal/external leaks and check prime valve for leaks.	Every 1000 gallons (3785 liters)
Throat packing adjustment When pump packing begins to leak after extended use, tighten packing nut down until leakage stops or lessens. This allows approximately 100 gallons of additional operation before a repacking is required. Packing nut can be tightened without O-ring removal.	As necessary based on usage



Maintenance can be scheduled and tracked via the Graco BlueLink app.

## Recycling and Disposal at End of Life

At the end of the product's useful life, dismantle and recycle it in a responsible manner.

### Preparation:

- Perform the **Pressure Relief Procedure**, page 12.
- Drain and dispose of fluids according to applicable regulations. Refer to the material manufacturer's Safety Data Sheet.

### Dismantle and recycle:

- Remove motors, circuit boards, displays, and other electronic components. Remove the coin-cell battery from the battery holder on the control board. Recycle according to applicable regulations.
- Do not dispose of electronic components with household or commercial waste.
- Deliver remaining product to a recycling facility.

## Troubleshooting

### Mechanical/Fluid Flow



1. Follow **Pressure Relief Procedure**, page 12, before checking or repairing.
2. Check all possible problems and causes before disassembling the unit.

Problem	What to Check If check is OK, go to next check	What to Do When check is not OK, refer to this column
Control board status light is blinking or the light is off and there is power to the sprayer.	Fault condition exists.	Determine fault correction from <b>Electrical</b> , page 30.
Pump output is low	Spray tip worn.	Follow <b>Pressure Relief Procedure</b> , page 12, then replace tip. See separate gun or tip manual.
	Spray tip clogged.	Relieve pressure. Check and clean spray tip.
	Paint supply.	Refill and reprime pump.
	Intake strainer clogged.	Remove and clean, then reinstall.
	Intake valve ball and piston ball are not seating properly.	Remove intake valve and clean. Check balls and seats for nicks; replace if necessary. See pump manual. Strain paint before using to remove particles that could clog pump.
	Fluid filter or tip filter is clogged or dirty.	Clean filter.
	Prime valve leaking.	Follow <b>Pressure Relief Procedure</b> , page 12, then repair prime valve.
	Verify pump does not continue to stroke when gun trigger is released. (Prime valve not leaking.)	Service pump. See pump manual.
Leaking around throat packing nut which may indicate worn or damaged packings.	Replace packings. See pump manual. Also check piston valve seat for hardened paint or nicks and replace if necessary. Tighten packing nut/wet-cup.	

# Troubleshooting

Problem	What to Check If check is OK, go to next check	What to Do When check is not OK, refer to this column
Pump output is low	Pump rod damage.	Repair pump. See pump manual.
	Low stall pressure.	Turn pressure knob fully clockwise. Make sure pressure control knob is properly installed to allow full clockwise position. If problem persists, replace pressure transducer.
	Piston packings are worn or damaged.	Replace packings. See pump manual.
	O-ring in pump is worn or damaged.	Replace o-ring. See pump manual.
	Intake valve ball is packed with material.	Clean intake valve. See pump manual.
	Large pressure drop in hose with heavy materials.	Reduce overall length of hose.
	Check extension cord for correct size.	See <b>Extension Cords</b> , page 11.
Motor runs but pump does not stroke	Connecting rod assembly damaged. See pump manual.	Replace connecting rod assembly. See pump manual.
	Gears or drive housing damaged.	Inspect drive housing assembly and gears for damage and replace if necessary.
Excessive paint leakage into throat packing nut	Throat packing nut is loose.	Remove throat packing nut spacer. Tighten throat packing nut just enough to stop leakage.
	Throat packings are worn or damaged.	Replace packings. See pump manual.
	Displacement rod is worn or damaged.	Replace rod. See pump manual.
Fluid is spitting from gun	Air in pump or hose.	Check and tighten all fluid connections. Cycle pump as slowly as possible during priming.
	Spray tip is partially clogged.	Clear tip. See <b>Clear Spray Tip Clog</b> , page 19.
	Fluid supply is low or empty.	Refill fluid supply. Prime pump. See pump manual. Check fluid supply often to prevent running pump dry.



<b>Problem</b>	<b>What to Check If check is OK, go to next check</b>	<b>What to Do When check is not OK, refer to this column</b>
Pump is difficult to prime	Air in pump or hose.	Check and tighten all fluid connections. Cycle pump as slowly as possible during priming.
	Intake valve is leaking.	Clean intake valve. Be sure ball seat is not nicked or worn and that ball seats well. Reassemble valve.
	Pump packings are worn.	Replace pump packings. See pump manual.
	Paint is too thick.	Thin the paint according to supplier recommendations.
Sprayer operates for 5 to 10 minutes then stops	Pump packing nut too tight. When pump packing nut is too tight the packings on the pump rod restrict pump action and overloads the motor.	Loosen pump packing nut. Check for leaks around throat. If necessary, replace pump packings. See Pump manual.

# Troubleshooting

## Electrical

Symptom: Sprayer does not run, stops running, or will not shut off.



Perform **Pressure Relief Procedure**, page 12.

1. Plug sprayer into correct voltage, grounded outlet.
2. Turn the ON/OFF switch **OFF** wait 30 seconds and then turn power back **ON** again (this ensures sprayer is in normal run mode).
3. Turn pressure control knob clockwise 1/2 turn.

4. Remove control box cover to view control board status light. To determine which code (or any other code besides voltage supply) refer to the control board status light. Turn the ON/OFF switch **OFF**, remove the control cover then turn power back **ON**. Observe the status light. Blinking LED total count equals the error code (for example: two blinks equals CODE 02).



Keep clear of electrical and moving parts during troubleshooting procedures. To avoid electrical shock hazards when covers are removed for troubleshooting, wait 5 minutes after disconnecting power cord for stored electricity to dissipate.



## Error Code Messages

CODE	MESSAGE	ACTION
02	HIGH PRESSURE DETECTED - RELIEVE PRESSURE	Check for clogs. Use only Graco spray hoses, use a minimum of 50ft/15m.
03	PRESSURE TRANSDUCER NOT DETECTED	Check transducer connection.
05	MOTOR NOT SPINNING	Check for mechanical failure and check motor connections. Material may be too thick, thin material.
06	MOTOR OVERHEATED	Turn sprayer OFF. Check motor connections. Check shroud vents for blockage. Sprayer may take up to an hour to cool.

Problem	What to Check	How to check
Sprayer does not run at all AND Control board status light never lights	See flow chart, page 35.	
Sprayer does not shut off AND Control board status light blinks 2 times repeatedly	Control board.	Replace control board.
Sprayer does not run at all AND Control board status light blinks 2 times repeatedly	Check transducer or transducer connections	<p>Make sure there is no pressure in the system (see <b>Pressure Relief Procedure</b>, page 12). Check fluid path for clogs, such as clogged filter.</p> <p>Use airless paint spray hose with no metal braid. A small hose or metal braid hose may result in high-pressure spikes.</p> <p>Turn ON/OFF switch <b>OFF</b> and disconnect power to sprayer.</p> <p>Check transducer and connections to control board.</p> <p>Disconnect transducer from control board socket. Check that transducer and control board contacts are clean and secure.</p> <p>Reconnect transducer to control board socket. Connect power, turn ON/OFF switch <b>ON</b> and control knob 1/2 turn clockwise. If sprayer does not run properly, turn ON/OFF switch <b>OFF</b> and go to next step.</p> <p>Install new transducer. Connect power, turn ON/OFF switch <b>ON</b> and control knob 1/2 turn clockwise. Replace control board if sprayer does not run properly.</p>

# Troubleshooting

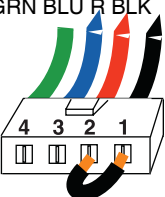
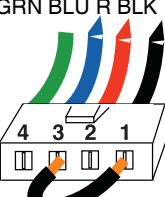
Problem	What to Check	How to check
<p>Sprayer does not run at all  <b>AND</b>            Control board status light blinks 3 times repeatedly</p>	<p>Check transducer or transducer connections (control board is not detecting a pressure signal).</p>	<p>Turn ON/OFF switch <b>OFF</b> and disconnect power to sprayer.</p> <p>Check transducer and connections to control board.</p> <p>Disconnect transducer from control board socket. Check to see if transducer and control board contacts are clean and secure.</p> <p>Reconnect transducer to control board socket. Connect power, turn ON/OFF switch <b>ON</b> and control knob to 1/2 turn clockwise. If sprayer does not run, turn ON/OFF switch <b>OFF</b> and go to next step.</p> <p>Connect a confirmed working transducer to control board socket.</p> <p>Turn ON/OFF switch <b>ON</b> and control knob to 1/2 turn clockwise. If sprayer runs, install new transducer. Replace control board if sprayer does not run.</p> <p>Check transducer resistance with an ohmmeter (less than 9k ohm between red and black wires and 3-6k ohm between green and yellow wires).</p>
<p>Sprayer does not run at all  <b>AND</b>            Control board status light blinks 5 times repeatedly</p>	<p>Control is commanding motor to run but motor shaft does not rotate. Possibly locked rotor condition, an open connection exists between motor and control, there is a problem with motor or control board, or motor amp draw is excessive.</p>	<ol style="list-style-type: none"> <li>1. Remove pump and try to run sprayer. If motor runs, check for locked or frozen pump or drive train. If sprayer does not run, continue to step 2.</li> <li>2. Turn ON/OFF switch <b>OFF</b> and disconnect power to sprayer.</li> <li>3. Disconnect motor connector(s) from control board socket(s). Check that motor connector and control board contacts are clean and secure. If contacts are clean and secure, continue to step 4.</li> <li>4. Set sprayer to OFF and spin motor fan 1/2 turn. Restart sprayer. If sprayer runs replace control board. If sprayer does not run, continue to step 5.</li> </ol>

Problem	What to Check	How to check
		<p>5. Perform Spin Test: Test at large 4-pin motor field connector. Disconnect fluid pump from sprayer. Test motor by placing a jumper across pins 1 &amp; 2. Rotate motor fan at about 2 revolutions per second. A cogging resistance to motion should be felt at the fan. The motor should be replaced if no resistance is felt. Repeat for pin combinations 1 &amp; 3 and 2 &amp; 3. Pin 4 (the green wire) is not used in this test. If all spin test is positive, continue to step 6.</p> <p><b>STEP 1:</b></p>  <p><b>STEP 2:</b></p>  <p><b>STEP 3:</b></p> 
		<p>6. Perform Field Short Test: Test at large 4-pin motor field connector. There should not be continuity from pin 4, the ground wire, and any of the remaining 3 pins. If motor field connector tests fail, replace motor.</p> <p>7. Reconnect motor connector(s) to control board socket(s). Connect power, turn ON/OFF switch <b>ON</b> and control knob to 1/2 turn clockwise. If motor does not run, replace control board.</p>

# Troubleshooting

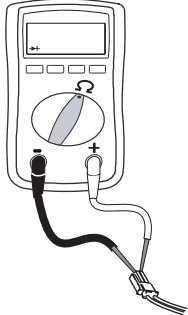
Problem	What to Check	How to check
<p>Sprayer does not run at all AND Control board status light blinks 6 times repeatedly</p>	<p>Motor is hot or there is a fault in the motor thermal device.</p>	<p>Allow sprayer to cool. If sprayer runs when cool, correct cause of overheating. Keep sprayer in cooler location with good ventilation. Make sure motor air intake is not blocked. If sprayer still does not run, replace motor.</p> <p><b>NOTE:</b> Motor must be cooled down for the test.</p> <ol style="list-style-type: none"> <li>1. Check thermal device connector (yellow wires) at control board.</li> <li>2. Disconnect thermal device connector from control board socket. Make sure contacts are clean and secure. Measure resistance of the thermal device. If reading is not correct, replace motor.</li> </ol>
		<p><b>Check Motor Thermal Switch:</b> Unplug thermal wires. Set meter to ohms. Meter should read 100k ohms.</p>  <ol style="list-style-type: none"> <li>3. Reconnect thermal device connector to control board socket. Connect power, turn sprayer ON and control knob 1/2 turn clockwise. If sprayer does not run, replace control board.</li> </ol>
<p>Basic electrical problems</p>	<p>Motor leads are securely fastened and properly mated</p>	<p>Replace loose terminals; crimp to leads. Be sure terminal are firmly connected.</p> <p>Clean circuit board terminals. Securely reconnect leads.</p>
	<p>Motor armature commutator for burn spots, gouges or extreme roughness.</p>	<p>Remove motor and have motor shop resurface commutator if possible.</p>

## Electrical cont...

### Sprayer Will Not Run

(See following page for steps)

#### Sprayer Will Not Run

(see following pages for steps)

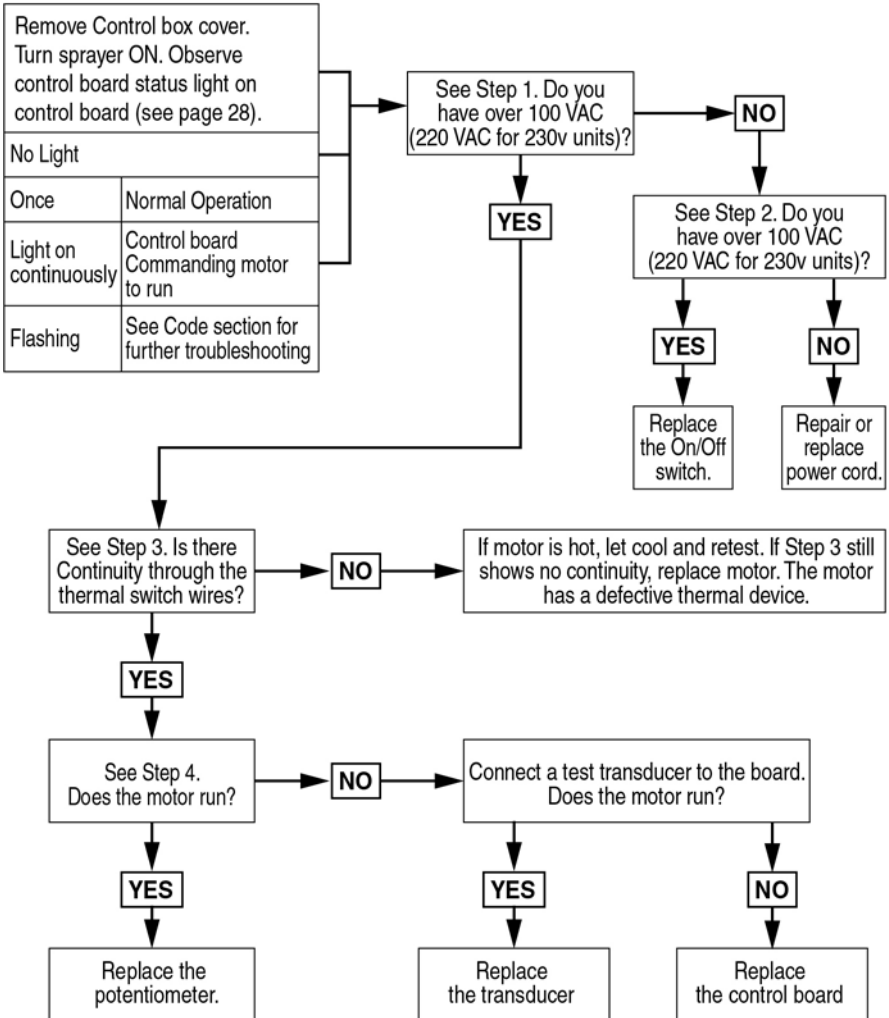

ti24726a

# Troubleshooting

## Step 1:

Plug Power cord in and turn switch ON. Connect probes to control board. Turn meter to AC Volts.

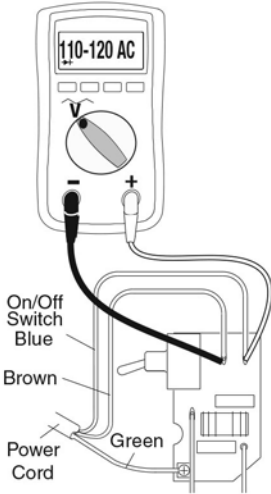

## Step 2:

Plug Power cord in and turn switch ON. Connect probes to control board. Turn meter to AC Volts

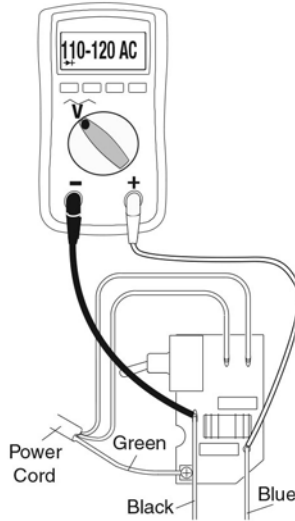

## Step 3:

Check motor thermal switch. Unplug yellow wires. Meter should read 100k ohms. NOTE: Motor should be cool during reading.

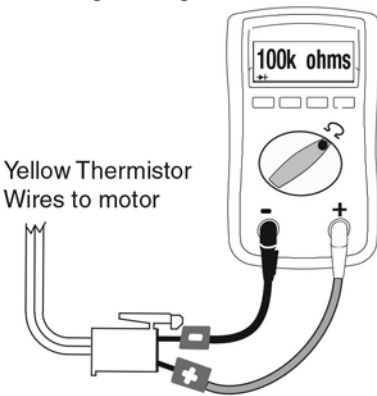

## Step 4:

Disconnect potentiometer. Plug power cord in and turn switch ON.

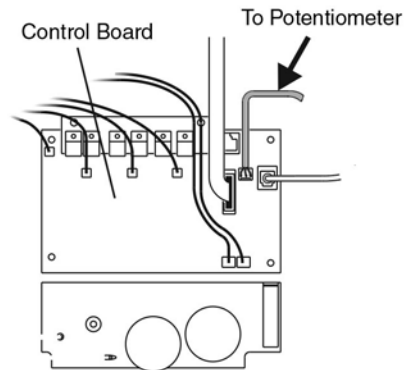

ti24084a



## Electrical cont...

### Sprayer Will Not Shut Off

1. Perform **Pressure Relief Procedure**, page 12. Leave prime valve open (down) and turn ON/OFF switch **OFF**.
2. Remove control box cover so the control board status light can be viewed if available.

### Troubleshooting Procedure

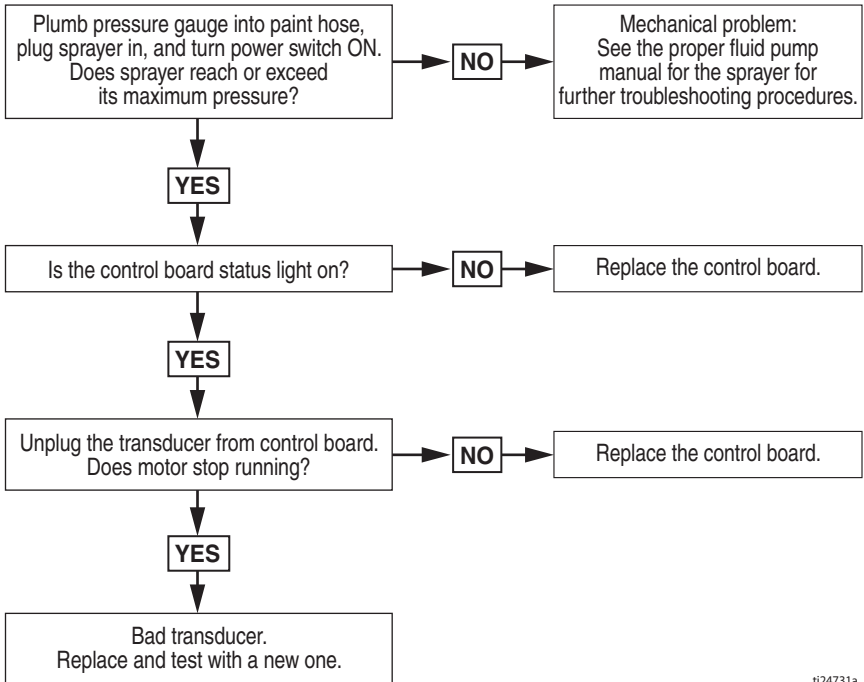

ti24731a

# 490/495/395EU Stand Sprayers

## 490/495/395EU Stand Sprayers

Ref.	Torque
△1	140-160 in-lb (15.8 - 18.1 N•m)
△2	23-27 in-lb (2.6 - 3.0 N•m)
△3	Hammer Tight
△4	20-30 ft-lb (33.9 - 40.7 N•m)

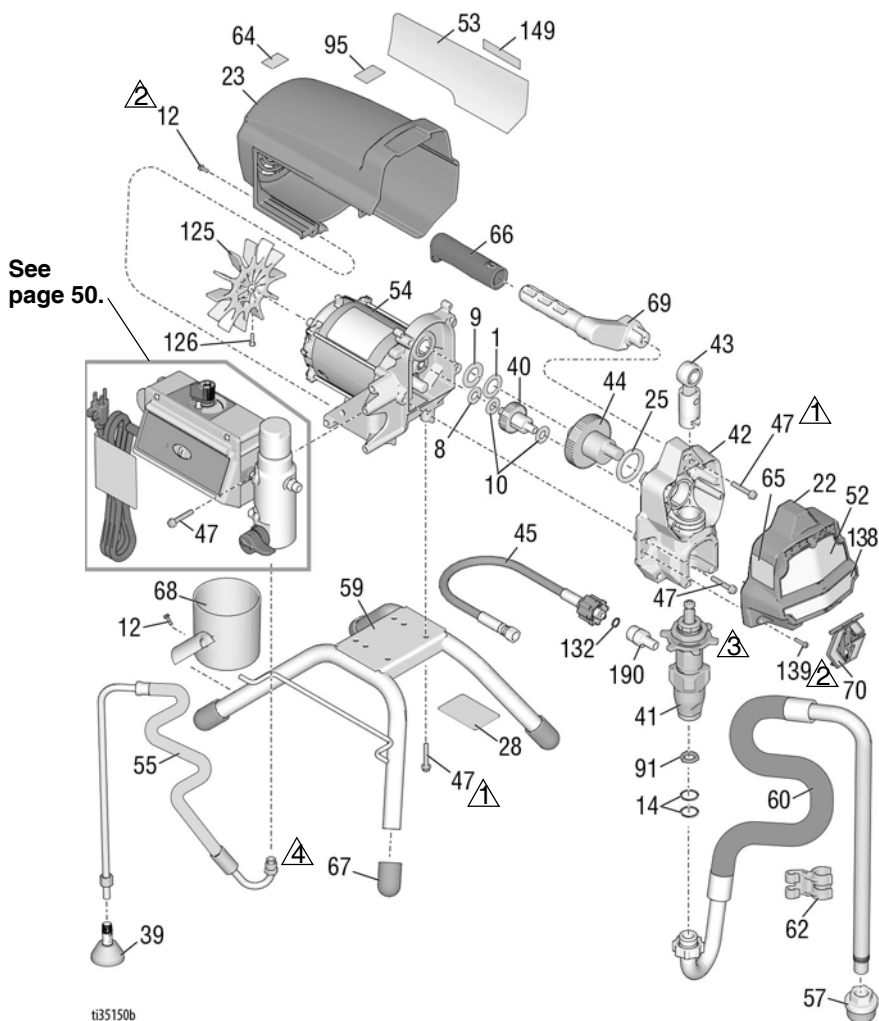

# 490/495/395EU Stand Sprayers

## 490/495/395EU Stand Sprayers Parts List

Ref.	Part	Description	Qty.	Ref.	Part	Description	Qty.
1	107434	BEARING, thrust	1	55	246381	HOSE, drain, stand, <i>includes 39, 62</i>	1
8	116073	WASHER, thrust	1	57	276897	STRAINER, 7/8-14 unf	1
9	116074	WASHER, thrust	1	59	19Y413	KIT, frame, standmount, <i>includes 67</i>	1
10	116079	BEARING, thrust	2	60	246386	KIT, hose suction, <i>includes 14, 57, 62</i>	1
12	117501	SCREW, mach, hex washer hd	9	61	See page 48	GUN, spray (not shown)	1
14	117559	O-RING	2	62	276888	CLIP, drain line	1
22	17C541	COVER, front, painted	1	63▲	See page 48	LABEL, warning	1
23	287900	SHIELD, motor, painted <i>includes 12</i>	1	64▲	16G596	LABEL, warning (Europe)	1
25	180131	BEARING, thrust	1	65▲	See page 48	LABEL, warning	1
28		LABEL, Identification, transparent	2	66	116139	GRIP, handle	1
33	238049	FLUID, TSL (not shown)	1	67	15G857	CAP, leg	4
34▲	See page 48	CARD, medical alert (not shown)	1	68	15G838	CUP, suction/drain	1
39	241920	DEFLECTOR, threaded	1	69	287072	HANDLE, sprayer, <i>includes 47, 66</i>	1
40	249194	GEAR, reducer	1	70	17C483	COVER, pump rod	1
41		PUMP, displacement, PC	1	91	115099	WASHER, garden hose	1
	17C487	North America		95	15Y118	LABEL, made in the USA	1
	17C488	Asia/ANZ/Japan/TW/Korea		125	287898	KIT, fan, includes 126	1
	17C489	Europe		126	115477	SCREW, mach, torx	1
42	24W817	HOUSING, drive, PC, <i>includes 10, 47</i>	1	132	16H137	O-RING, FX-90	1
43	24W640	ROD, connecting, PC	1	139	127914	SCREW, mach, slot, hex	3
44	24X020	KIT, repair, crankshaft, <i>includes 25</i>	1	149		LABEL, home center	1
45	24W830	KIT, hose, cpld, PC, <i>includes 132</i>	1		17P924	490, 495	
46	See page 48	HOSE, cpld, 1/4 in. x 50 ft (not shown)	1		17P925	395EU	
47	117493	SCREW, mach, hex washer hd	13	190	17C231	FITTING, pump, 1/4 NPT	1
52	See page 48	LABEL, front, upper/lower	1				
53	See page 48	LABEL, side	1				
54		MOTOR, <i>includes 1, 8, 9, 10, 125, 126</i>	1				
	287805	490/495/395EU					
					206994	FLUID, TSL, 8 oz. (not shown)	1

▲ Replacement safety labels, tags, and cards are available at no cost.

# 490/495/595 Lo-Boy Sprayers

## 490/495/595 Lo-Boy Sprayers

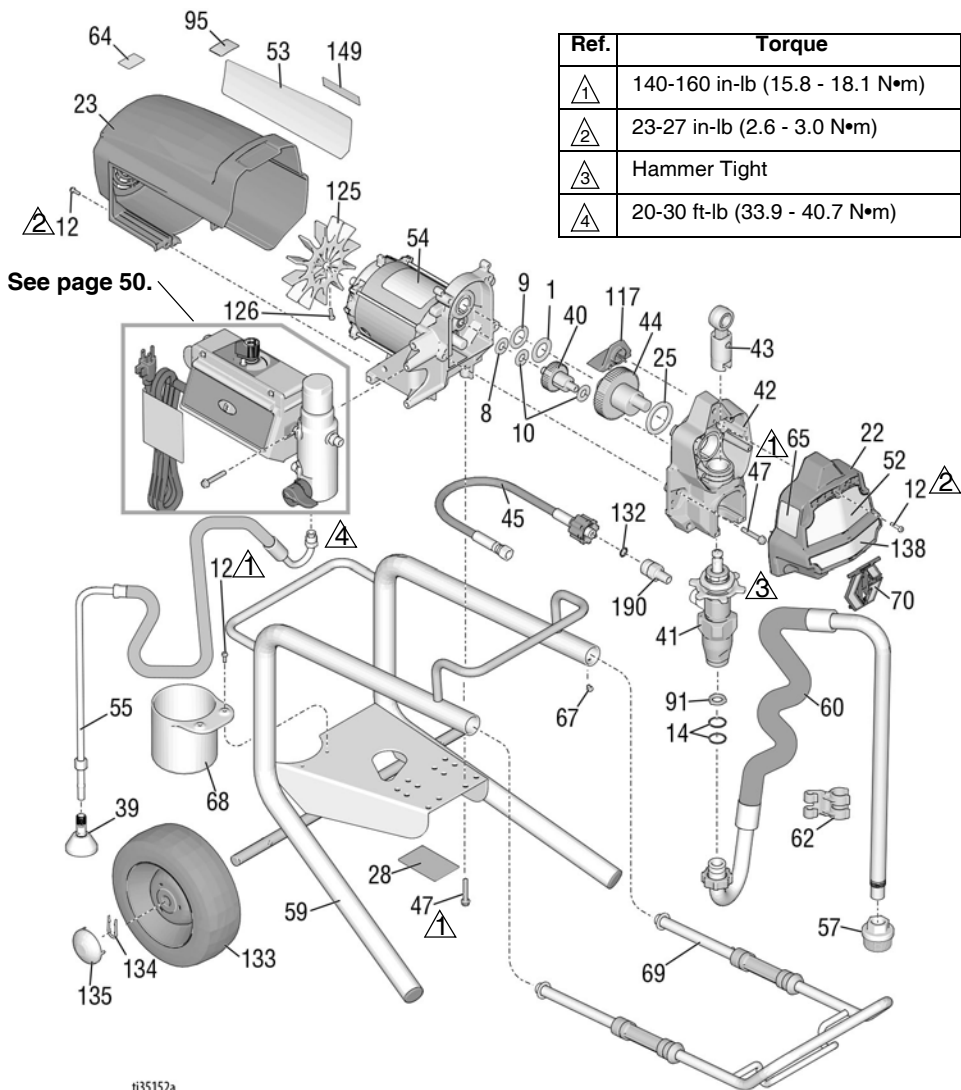

# 490/495/595 Lo-Boy Sprayers

## 490/495/595 Lo-Boy Sprayers Parts List

Ref. Part	Description	Qty.	Ref. Part	Description	Qty.
1	107434 BEARING, thrust	1		287807 Model 595	
8	116073 WASHER, thrust	1	55	246381 HOSE, drain, stand, <i>includes 39, 62</i>	1
9	116074 WASHER, thrust	1	57	276897 STRAINER, 7/8-14 unf	1
10	116079 BEARING, thrust	2	59	246250 FRAME, cart, lo	1
12	117501 SCREW, mach, hex washer hd	10	60	246386 KIT, hose suction, <i>includes 14, 57, 62</i>	1
14	117559 O-RING	2	61	See page 48 GUN, spray (not shown)	1
22	17C541 COVER, front, painted	1	62	276888 CLIP, drain line	1
23	287900 SHIELD, motor, painted <i>includes 12</i>	1	63▲	See page 48 LABEL, warning	1
25	180131 BEARING, thrust	1	64▲	16G596 LABEL, warning (Europe)	1
28	LABEL, identification, transparent	2	65▲	See page 48 LABEL, warning	1
34▲	See page 48 CARD, medical alert (not shown)	1	67	109032 SCREW, mach hd., pnh	4
39	241920 DEFLECTOR, threaded	1	68	15B870 CUP, suction/drain	1
40	249194 GEAR, reducer	1	69	287488 HANDLE, assembly, lo cart	1
41	PUMP, displacement, PC 17C487 North America 17C488 Asia/ANZ/Japan/TW/Korea	1	70	17C483 COVER, pump, rod	1
42	24W817 HOUSING, drive, PC, <i>includes 10, 47</i>	1	91	115099 WASHER, garden hose	1
43	24W640 ROD, connecting, PC	1	95	15Y118 LABEL, made in the USA	1
44	KIT, repair, crankshaft, <i>includes 25</i>	1	117	15G447 PLUG, shield painted	1
	24X020 Models 490/495		125	287898 KIT, fan, includes 126	1
	24X021 Model 595		126	115477 SCREW, mach hd., torx	1
45	24W830 KIT, hose, cpld, PC, <i>includes 132</i>	1	132	16H137 O-RING, FX-90	1
46	See page 48 HOSE, cpld, 1/4 in. x 50 ft (not shown)	1	133	195766 WHEEL, semi pneumatic	2
47	117493 SCREW, mach, hex washer hd	12	134	15B999 CLIP, retaining	2
52▲	See page 48 LABEL, front, upper/lower	1	135	104811 CAP, hub	2
53▲	See page 48 LABEL, side	1	149	17P924 LABEL, home center	1
54	MOTOR, <i>includes 1, 8, 9, 10, 125, 126</i>	1	190	17C231 FITTING, pump, 1/4 NPT	1
	287805 Models 490/495			206994 FLUID, TSL, 8 oz. (not shown)	1

▲ Replacement safety labels, tags, and cards are available at no cost.

# 650 Lo-Boy Sprayer

## 650 Lo-Boy Sprayer

Ref.	Torque
⚠	140-160 in-lb (15.8 - 18.1 N•m)
⚠	30-35 in-lb (3.4 - 4.0 N•m)
⚠	Hammer Tight
⚠	20-30 ft-lb (33.9 - 40.7 N•m)

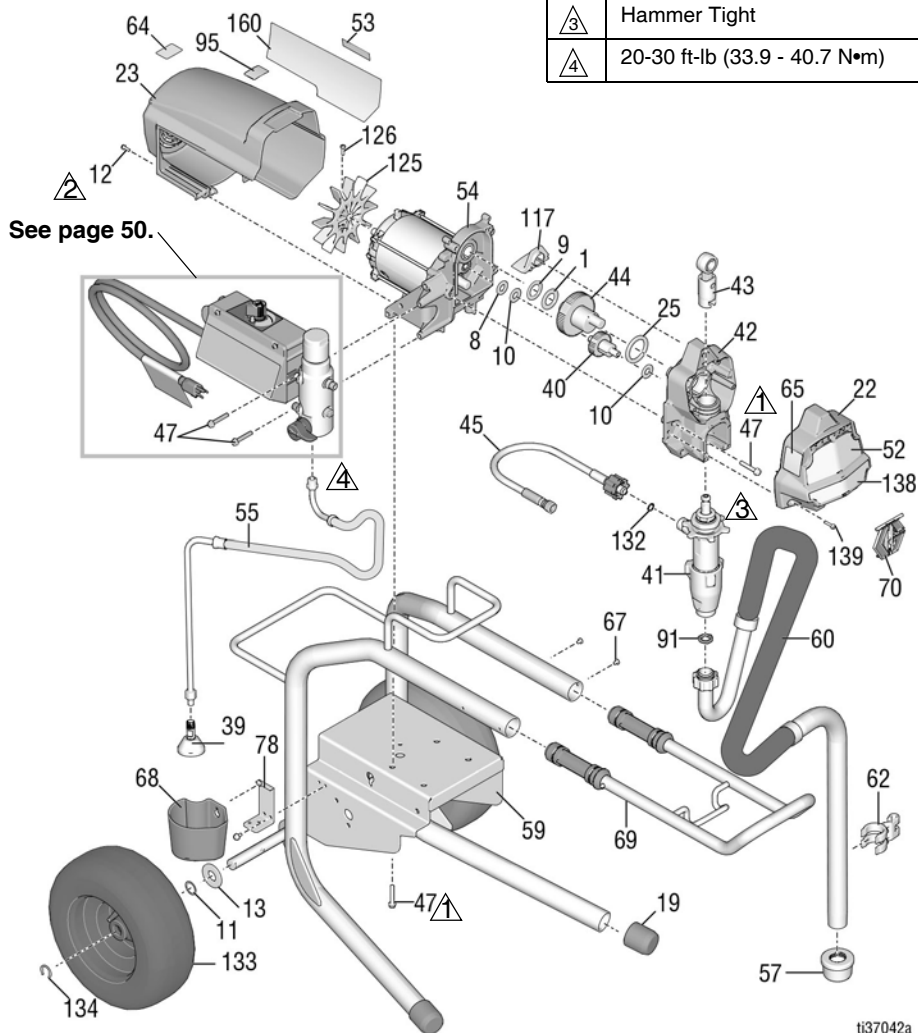

## 650 Lo-Boy Sprayers Parts List

Ref. Part	Description	Qty.	Ref. Part	Description	Qty.
1	107434 BEARING, thrust	1	59	24Y424 FRAME, cart, lo	1
8	116073 WASHER, thrust	1	60	248216 KIT, hose suction	1
9	116074 WASHER, thrust	1	61	See page 48 GUN, spray (not shown)	1
10	116079 BEARING, thrust	2	62	15D000 CLIP, drain line	1
11	116038 WASHER, wave spring	2	63▲	See page 48 LABEL, warning	1
12	117501 SCREW, mach, hex washer hd	8	64▲	16G596 LABEL, warning (Europe)	1
13	156306 WASHER, flat	2	65▲	See page 48 LABEL, warning	1
19	15C871 CAP, leg	2	67	109032 SCREW, mach	4
22	17C541 COVER, front, painted	1	68	276975 CUP, drain	1
23	287900 SHIELD, motor, painted <i>includes 12</i>	1	69	24A249 HANDLE, assembly, lo cart	1
25	180131 BEARING, thrust	1	70	17C483 COVER, pump, rod	1
34▲	See page 48 CARD, medical alert (not shown)	1	78	15F952 BRACKET, drain cup	1
39	241920 DEFLECTOR, threaded	1	91	115099 WASHER, garden hose	1
40	249194 GEAR, reducer	1	95	15Y118 LABEL, made in USA	1
41	19Y298 PUMP, displacement, PC	1	117	15G447 PLUG, shield painted	1
42	24W817 HOUSING, drive, PC, <i>includes 10, 47</i>	1	125	287898 KIT, fan, includes 126	1
43	24W640 ROD, connecting, PC	1	126	115477 SCREW, mach, torx	1
44	300001 KIT, repair, crankshaft, includes 1, 9, 25	1	132	16H137 O-RING, FX-90	1
45	24W830 HOSE, coupled, 1/4 in., includes 132	1	133	119420 WHEEL, semi-pneumatic	2
47	117493 SCREW, mach, hex washer hd	12	134	15E891 CLIP, retaining	2
52▲	See page 48 LABEL, front	1	139	127914 SCREW, mach, slot, hex	3
53▲	See page 48 LABEL, side	1	160	17P924 LABEL, home center	1
54	287807 MOTOR, <i>includes 1, 8, 9, 10, 125, 126</i>	1	206994	FLUID, TSL, 8 oz. (not shown)	1
55	248217 HOSE, drain, stand, <i>includes 39</i>	1	▲ <i>Replacement safety labels, tags, and cards are available at no cost.</i>		
57	112604 STRAINER	1			





# 490/495/595/395EU Hi-Boy Sprayers

## 490/495/595/395EU Hi-Boy Sprayers Parts List

Ref.	Part	Description	Qty.	Ref.	Part	Description	Qty.
1	107434	BEARING, thrust	1	61	See page 48	GUN, spray (not shown)	1
8	116073	WASHER, thrust	1	62	276888	CLIP, drain line	1
9	116074	WASHER, thrust	1	63▲	See page 48	LABEL, warning	1
10	116079	BEARING, thrust	2	64▲	16G596	LABEL, warning (Europe)	1
12	117501	SCREW, mach, hex washer hd	8	65▲	See page 48	LABEL, warning	1
14	103413	PACKING, O-ring	1	67	109032	SCREW, mach, pan hd	4
22	17C541	COVER, front, painted	1	69	287489	HANDLE, assembly, hi cart	1
23	287900	SHIELD, motor, painted <i>includes 12</i>	1	70	17C483	COVER, pump rod	1
25	180131	BEARING, thrust	1	84	15B652	WASHER, suction	1
28		LABEL, identification, transparent	1	91	115099	WASHER, garden hose	1
33	238049	FLUID, TSL (not shown)	1	95	15Y118	LABEL, made in the USA	1
34▲	See page 48	CARD, medical alert (not shown)	1	96	15E813	NUT, jam	1
39	241920	DEFLECTOR, threaded	1	107	111040	NUT, lock, insert, nylock, 5/16	2
40	249194	GEAR, reducer	1	114	15D281	HANGER, stand (on select models)	1
41		PUMP, displacement, PC North America	1	115	15C982	CAM, cart (on select models)	2
	17C487	Asia/ANZ/Japan/TW/Korea		116	114531	SCREW, mch, hex (on select models)	4
	17C488	Europe		117	15G447	PLUG, shield, painted	1
	17C489			122	118852	SCREW, thrd. forming (on select models, not shown)	3
42	24W817	HOUSING, drive, PC, <i>includes 10, 47</i>	1	123	287253	KIT, tool box, <i>includes 122</i> (on select models, not shown)	1
43	24W640	ROD, connecting, PC	1	125	287898	KIT, fan, includes 126	1
44		KIT, repair, crankshaft, <i>includes 25</i>	1	126	115477	SCREW, mach, torx	1
	24X020	Models 395EU/490/495		132	16H137	O-RING, FX-90	1
	24X021	Model 595		133	106062	WHEEL, semi pneumatic	2
45	24W830	KIT, hose, cpld, PC, <i>includes 132</i>	1	134	15B999	CLIP, retaining	2
46	See page 48	HOSE, cpld, 1/4 in. x 50 ft (not shown)	1	135	104811	CAP, hub	2
47	117493	SCREW, mach, hex washer hd	12	136	17C990	HANGER, pail, threaded	1
52▲	See page 48	LABEL, front, upper/lower	1	139	127914	SCREW, mach, slot, hex	3
53▲	See page 48	LABEL, side	1	149		LABEL, home center	1
54		MOTOR, <i>includes 1, 8, 9, 10, 125, 126</i>	1		17P924	490/495/595	
	287805	490/495/395EU			17P925	395EU	
	287807	595		206994	FLUID, TSL, 8 oz. (not shown)		1
55	287952	HOSE, drain, <i>includes 39</i>	1				
57	276897	STRAINER, 7/8-14 UNF	1				
59	17C485	FRAME, cart, hi	1				
60	17C992	KIT, stinger tube, <i>includes 14, 57, 84, 91, 96</i>	1				

▲ Replacement safety labels, tags, and cards are available at no cost.

# 650 Hi-Boy Sprayer

## 650 Hi-Boy Sprayer

Ref.	Torque
①	140-160 in-lb (15.8 - 18.1 N•m)
②	30-35 in-lb (3.4 - 4.0 N•m)
③	23-27 in-lb (2.6 - 3.0 N•m)
④	Hammer tight
⑤	25-30 ft-lb (33.9 - 40.7 N•m)

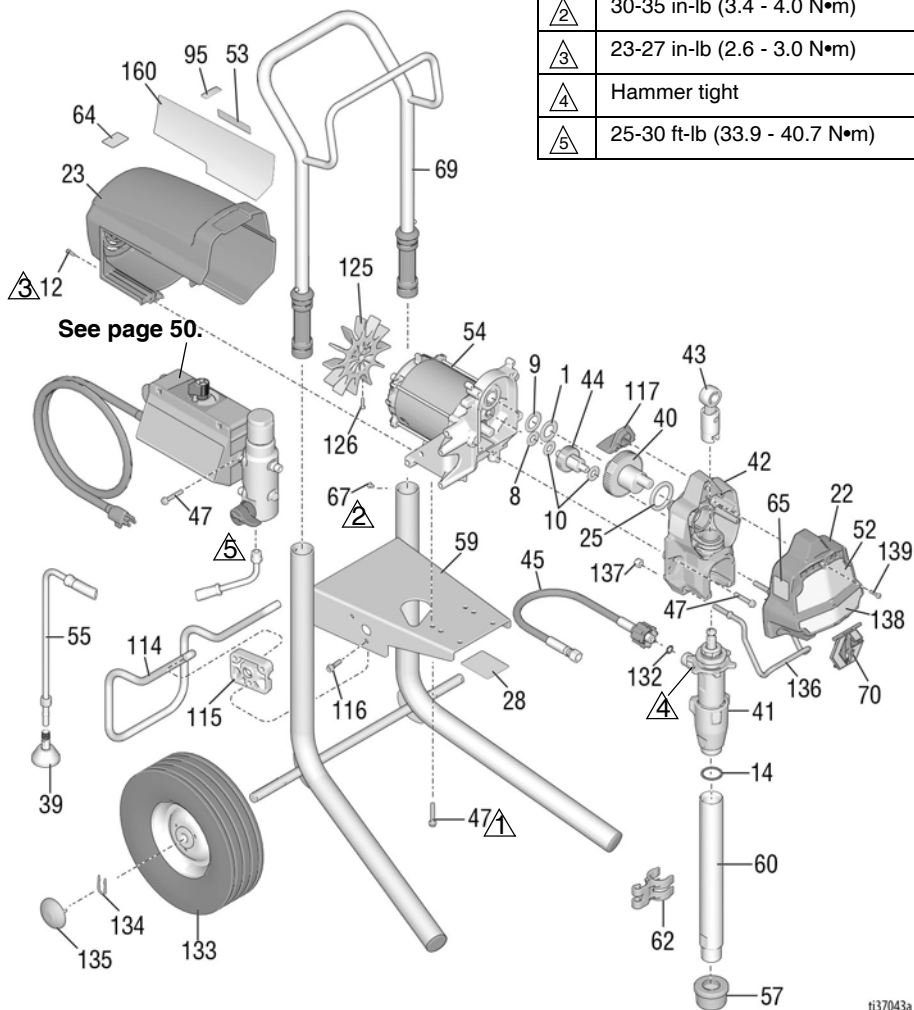

## 650 Hi-Boy Sprayers Parts List

Ref.	Part	Description	Qty.	Ref.	Part	Description	Qty.
1	107434	BEARING, thrust	1	59	17C485	FRAME, cart, hi	1
8	116073	WASHER, thrust	1	60	19Y309	KIT, stinger tube, <i>includes 14</i>	1
9	116074	WASHER, thrust	1	61	See page 48	GUN, spray (not shown)	1
10	116079	BEARING, thrust	2	62	15D000	CLIP, drain line	1
12	117501	SCREW, mach, hex washer hd	8	63▲	See page 48	LABEL, warning	1
14	118494	PACKING, o-ring	1	64▲	16G596	LABEL, warning (Europe)	1
22	17C541	COVER, front, painted	1	65▲	See page 48	LABEL, warning	1
23	287900	SHIELD, motor, painted <i>includes 12</i>	1	67	109032	SCREW, pan hd	4
25	180131	BEARING, thrust	1	69	287489	HANDLE, assembly, hi-cart	1
28		LABEL, identification, transparent	2	70	17C483	COVER, pump rod	1
33	238049	FLUID, TSL (not shown)	1	95	15Y118	LABEL, made in the USA	1
34▲	See page 48	CARD, medical alert (not shown)	1	114	15D281	HANGER, stand	1
39	241920	DEFLECTOR, threaded	1	115	15C982	CAM, cart	2
40	249194	GEAR, reducer	1	116	114531	SCREW, mch, hex	4
41	19Y298	PUMP, displacement, PC	1	117	15G447	PLUG, shield, painted	1
42	24W817	HOUSING, drive, PC, <i>includes 10, 47</i>	1	125	287898	KIT, fan, <i>includes 126</i>	1
43	24W640	ROD, connecting, PC	1	126	115477	SCREW, mach, torx	1
44	300001	KIT, repair, crankshaft, <i>includes 1, 9, 25</i>	1	132	16H137	O-RING, FX-90	1
45	24W830	KIT, hose, cpld, PC, <i>includes 132</i>	1	133	106062	WHEEL, semi pneumatic	2
46	See page 48	HOSE, cpld, 1/4 in. x 50 ft (not shown)	1	134	15B999	CLIP, retaining	2
47	117493	SCREW, mach, hex washer hd	12	135	104811	CAP, hub	2
52▲	See page 48	LABEL, front, upper/lower	1	136	17C990	HANGER PAIL, threaded	1
53▲	See page 48	LABEL, side	1	137	111040	NUT, lock, insert, nylock, 5/16	2
54	287807	MOTOR, <i>includes 1, 8, 9, 10, 125, 126</i>	1	139	127914	SCREW, mach, slot, hex	3
55	287952	HOSE, drain, <i>includes 39</i>	1	160	17P924	LABEL, home center	1
57	112604	STRAINER	1	206994	FLUID, TSL, 8 oz. (not shown)		1

▲ Replacement safety labels, tags, and cards are available at no cost.

# Accessories and Labels

## Accessories and Labels





Sprayer Model	Ref. 34 Card, Medical Alert	Ref. 46 Hose, 1/4 in. x 50 ft	Ref. 52 Label, Front, Upper/Lower	Ref. 53 Label, Side	Ref. 61 Gun, Spray	Ref. 63 Label, Warning	Ref. 65 Label, Warning
826243 826244 826245	222385 #	826079	17E947/17E945	17E948	826252	15H085 #	195793 &
826246 826247 826248	222385 #	826079	17E947/17E949	17E951	826252	15H085 #	195793 &
826249 826250	222385 #	826079	17E947/17E952	17E954	826252	15H085 #	195793 &
826258 826259	222385 #	826079	17E947/19Y232	19Y231	826252	15H085 #	195793 &
19Y128 19Y129	222385 #	240794	17E944/19Y232	19Y233	17Y042	15H085 #	195793 &
19Y359 19Y361	222385 #	240794	17E944/19Y232	19Y233	17Y043	n/a	n/a
19Y360 19Y362	222385 #	240794	17E944/19Y232	19Y233	17Y043	n/a	n/a
19Y424	17A134 ❖	240794	17E944/19Y232	19Y233	17Y044	15H087 ❖	195792 @
17E852 17E853 17E854	222385 #	240794	17E944/17E945	17E946	17Y042	15H085 #	195793 &
17E855 17E856 17E857	222385 #	240794	17E944/17E949	17E950	17Y042	15H085 #	195793 &
17E858 17E859	222385 #	240794	17E944/17E952	17E953	17Y042	15H085 #	195793 &
17E864 17E865	222385 #	240794	17E967/17E969	17E970	17Y043		
17E871 17E872 17E873 17E874 17E875 17E870	222385 #	240794	17E967/17E949	17E971	17Y043	n/a	n/a
17E876 17E877 17E878	222385 #	240794	17E967/17E952	17E972	17Y043	n/a	n/a
17E887	17A134 ❖	240794	17E944/17E945	17E946	17Y044	15H087 ❖	195792 @
17E889 17E891 17E892	17A134 ❖	240794	17E944/17E949	17E950	17Y044	15H087 ❖	195792 @
17E896 17E897	17A134 ❖	240794	17E944/17E952	17E953	17Y044	15H087 ❖	195792 @
26C970	17A134 ❖ 26A997 ★	240794	17E944/19Y232	17E946	17Y044	15H087 ❖ 26A971 ★	195792 @ 26A793 ★
26C974	17A134 ❖ 26A997 ★	240794	17E944/17E949	17E950	17Y044	15H087 ❖ 26A971 ★	195792 @ 26A793 ★
26C77 26C76	17A134 ❖ 26A997 ★	240794	17E944/17E952	17E953	17Y044	15H087 ❖ 26A971 ★	195792 @ 26A793 ★

# Accessories and Labels

Sprayer Model	Ref. 34 Card, Medical Alert	Ref. 46 Hose, 1/4 in. x 50 ft	Ref. 52 Label, Front, Upper/Lower	Ref. 53 Label, Side	Ref. 61 Gun, Spray	Ref. 63 Label, Warning	Ref. 65 Label, Warning
26C979 17Y424	17A134 ❖ 26A997 ★	240794	17E944/19Y232	19Y233	17Y044	15H087 ❖ 26A971 ★	195792 @ 26A793 ★
26C971	26A998*	240794	17E944/19Y232	17E946	17Y044	15H086*	195792@
26C975	26A998*	240794	17E944/17E949	17E950	17Y044	15H086*	195792@
26C978	26A998*	240794	17E944/17E592	17E953	17Y044	15H086*	195792@
26C980	26A998*	240794	17E944/19Y232	19Y233	17Y044	15H086*	195792@
288526 – Kit, accessory, hopper							
# – English, Spanish, French				@ – Asia Pacific			
❖ – English, Chinese, Korean				✓ – Europe			
& – North America				* – English, Chinese, Japanese			
★ – English, Indonesian, Hindi							
▲ Replacement safety labels, tags, and cards are available at no cost.							

# Control Box

## Control Box

Ref.	Torque
	140-160 in-lb (15.8 - 18.1 N•m)
	20-25 in-lb (2.3 - 2.8 N•m)
	37-43 ft-lb (50.2 - 58.3 N•m)
	130-150 in-lb (14.7 - 16.9 N•m)

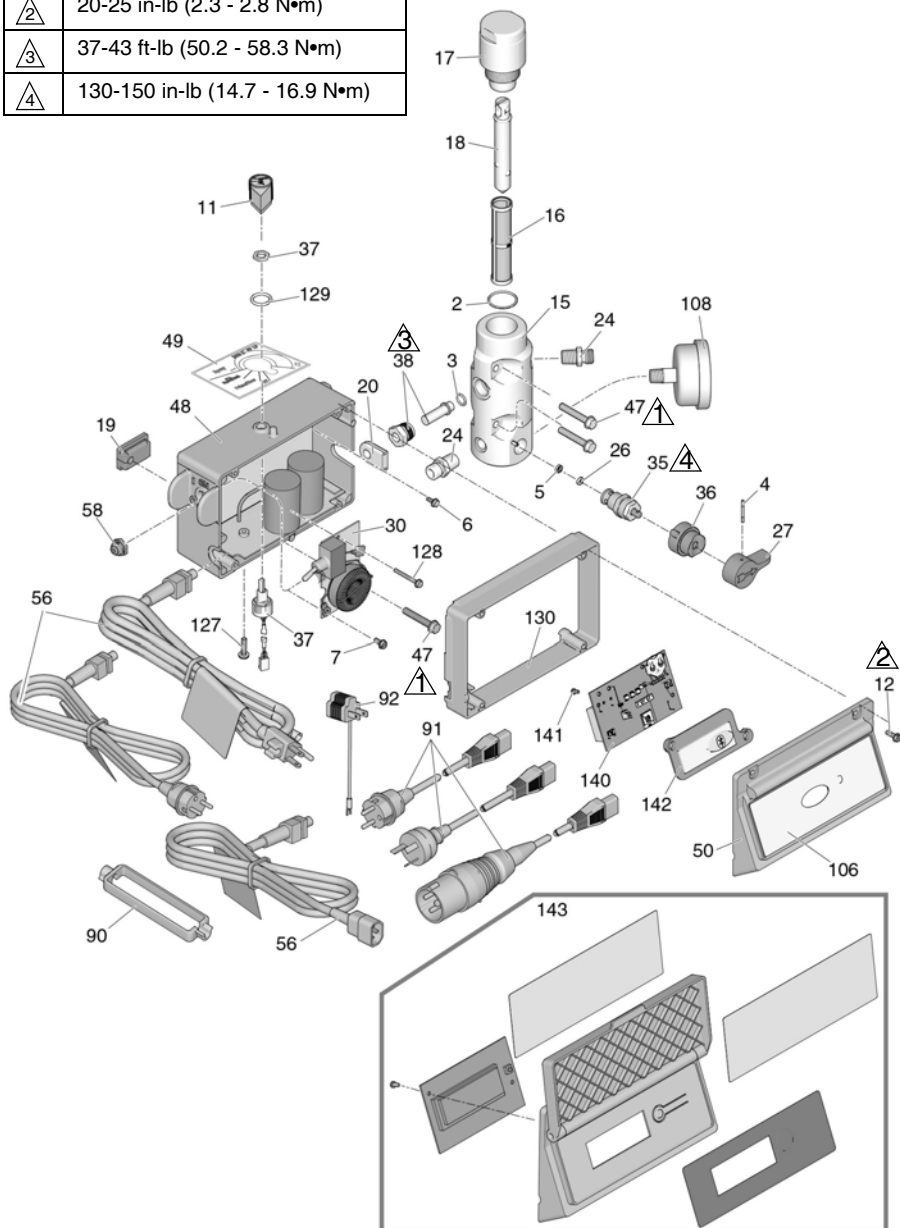

837220a

## Control Box Parts List

Ref. Part	Description	Qty.	Ref. Part	Description	Qty.	
2	117828	PACKING, o-ring	1	19Y382	230V, 650 models	
3	111457	PACKING, o-ring	1	19Y383	110V, 650 models	
4	111600	PIN, grooved	1	49	17P731	LABEL, pressure, adjustment, w/FastFlush
5	277364	GASKET, seat, valve	1	50		COVER, control
6	120405	SCREW, mach, Phillips, pan hd	5	17Y568	BlueLink	
7	123850	SCREW, slot, hex, wash hd	1	56		CORD, power
11	116167	KNOB, potentiometer	1	253367	US, 490/495 models	
12		SCREW, mach, hex washer hd	4	253371	US, 595/650 models	
	117501	1/2", 120V models, US/Japan		253378	Japan	
	17Z216	1-1/2", 110V UK and 230V (650 Models)		253373	Multicord, Asia/ANZ	
15		MANIFOLD, fluid	1	253369	CEE 7/7	
	15G455	One output port models		253370	Multicord, Europe	
	15T811	Two output port models		58	195428	BOOT, toggle
16		FILTER, fluid	1	90	195551	RETAINER, plug, adapter
	246425	30 mesh				Multicord models
	246384	60 mesh, original		91		CEE 7/7 models
	246382	100 mesh				CORD SET, adapter
	246383	200 mesh				UK
17	287902	KIT, repair, filter cap <i>includes 18</i>	1	253368	Europe	
18	15B071	INSERT, filter	1	242001	Australia	
19	15G562	BUSHING, control box	1	242005	Italy, Denmark, Switzerland	
20	15B120	GROMMET, transducer	1	287121	India	
24	162453	NIPPLE, (1/4 npsm x 1/4 npt)	2	17N232	ADAPTER, Japan	1
26	15E022	SEAT, valve	1	92	244285	LABEL, BlueLink
27	187625	HANDLE, valve, drain	1	106		490/495/595 Models
30		BOARD, filter	1	108	115523	GAUGE, pressure, fluid (on select models)
	287911	120V, GFI, US/Japan		127	120165	SCREW, mach, Phillips, pan hd
	287912	110V, UK		128	120406	SCREW, mach, hex washer hd
	287913	230V		129	158674	O-RING, packing
35	239914	VALVE, drain <i>includes 5, 26</i>	1	130	17Z189	SPACER, box, control, 110V UK and 230V (490/495/595 models only)
36	224807	BASE, valve	1	140	‡	BOARD, control, BlueLink (490/495/595 models only)
37	17D888	POTENTIOMETER, adj, pressure with nut	1	141	115522	SCREW, mach, pan hd
38	243222	TRANSDUCER, prs control, <i>includes 3</i>	1	142	17Y405	LENS, BlueLink (Models 490/495/595 only)
47	117493	SCREW, mach, hex washer hd	4	143	24W892	DISPLAY, smart control (650 models)
48	‡	BOX, control board with battery* <i>includes 6, 7, 11, 19, 30, 37, 49, 50, 58, 106, 127, 128, 129, 140, 141, 142</i>	1			KIT, ProGuard+, 230V models only (not shown)
	17Z260	120V, 490/495 models, US/Japan <i>includes 19</i>				24W090
	17Z261	120V, 595 models, US/Japan <i>includes 19</i>				24W755
	17Z262	230V, 490/495/595 models				Multicord, IEC-320
	17Z263	110V, UK, 490/495/595 models				
	19Y365	120V, 650 Model				

\* - Use battery CR2032

‡ - Control boards (48 &amp; 140) are a matched pair, if separated some BlueLink features will not function.

# Battery Replacement

## Battery Replacement

(BlueLink Units Only)

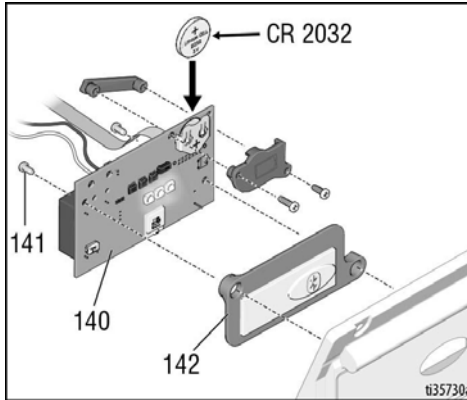



# Wiring Diagrams

## 100V JP-TW/120V

Models 395EU, 490, 495, 595

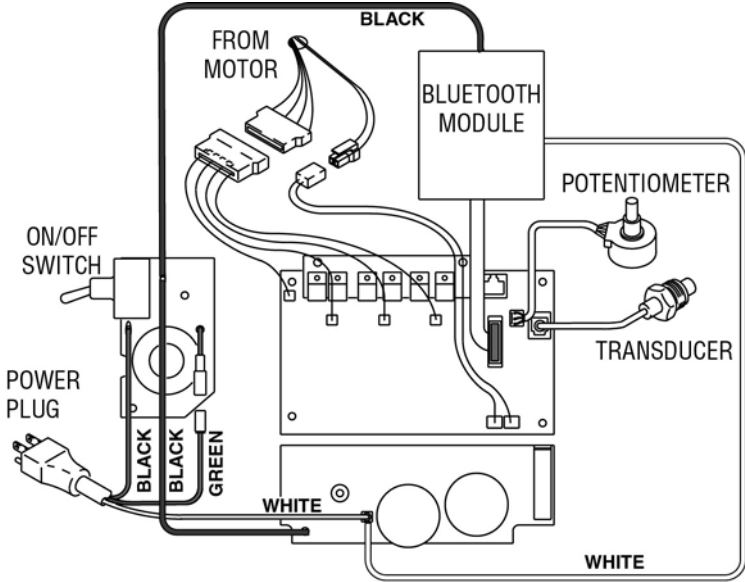

t35307a

# Wiring Diagrams

## 110V UK/230V

Models 490, 495, 595

### NOTICE

Heat from inductor coil of filter board may destroy wire insulation that comes in contact with it. Exposed wires could cause shorts and component damage. Bundle and tie loose wires so none lay in contact with inductor coil on the filter board.

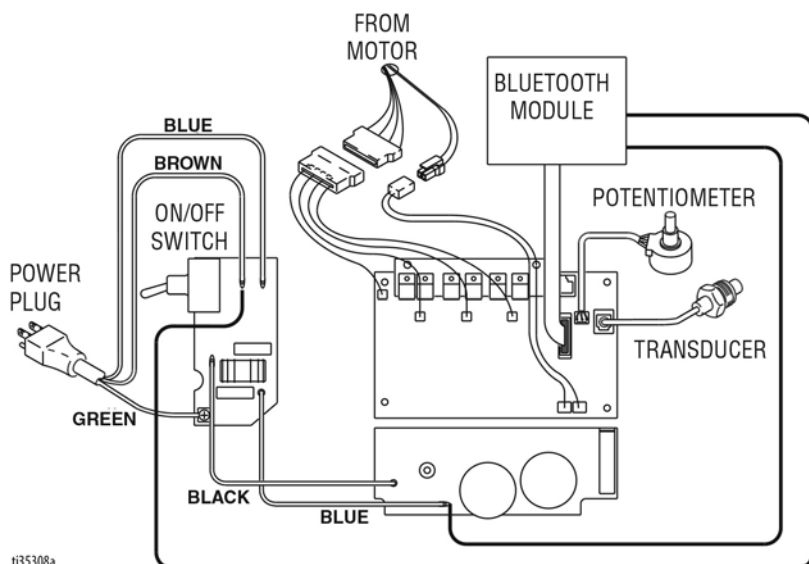

ti35308a

100V JP-TW/120V

Model 650

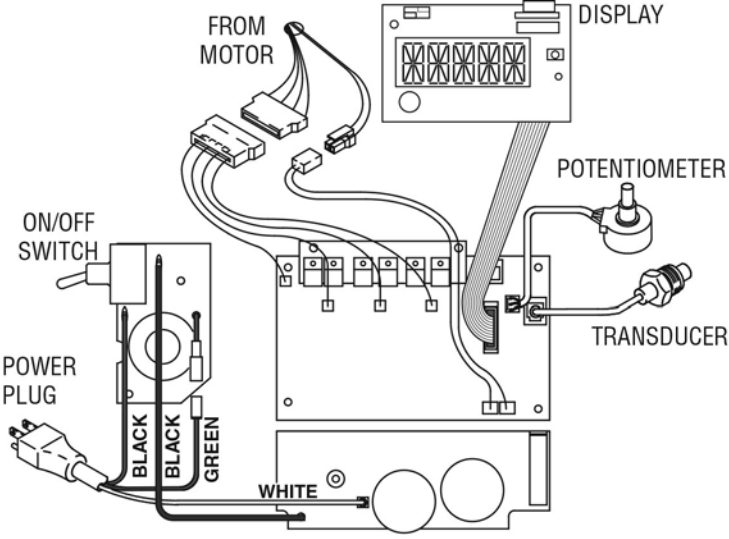

t137221 a

# Wiring Diagrams

## 110V UK/230V

### Model 650

#### NOTICE

Heat from inductor coil of filter board may destroy wire insulation that comes in contact with it. Exposed wires could cause shorts and component damage. Bundle and tie loose wires so none lay in contact with inductor coil on the filter board.

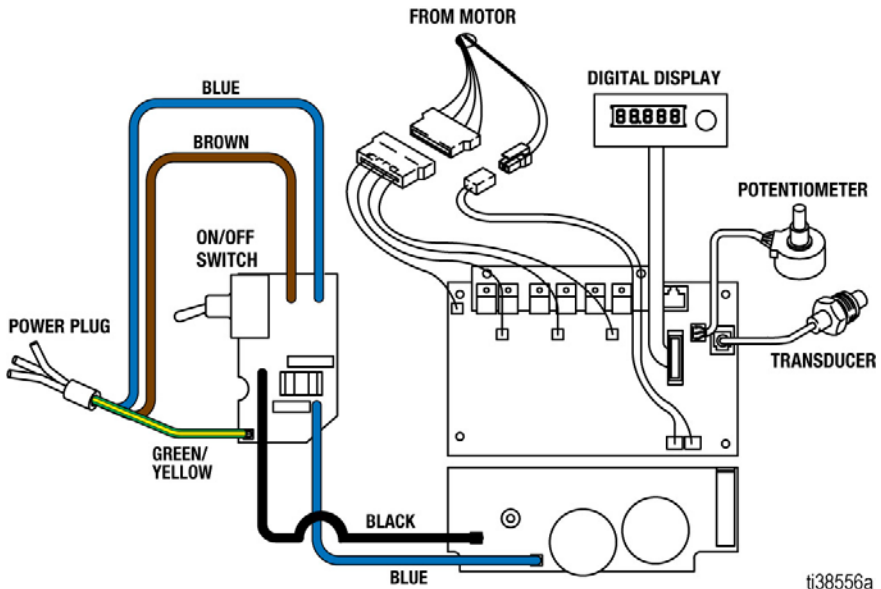



# Technical Specifications

## Technical Specifications

490/495/595/650/395EU		
	US	Metric
<b>Sprayer</b>		
Maximum fluid working pressure	3300 psi	228 bar, 22.8 MPa
Maximum Delivery		
395EU/490	0.54 gpm	2.0 lpm
495	0.60 gpm	2.3 lpm
595	0.70 gpm	2.6 lpm
650	0.80 gpm	3.0 lpm
Maximum Tip Size		
395EU/490	0.023	0.023
495	0.025	0.025
595	0.027	0.027
650	Single Gun	
	0.029	0.029
	Two Guns	
	0.019	0.019
Fluid Outlet npsm	1/4 in.	1/4 in.
Cycles		
395EU/490/495	720 per gallon	190 per liter
595	620 per gallon	164 per liter
650	570 per gallon	150 per liter
Generator Minimum		
395EU/490	3500 W	
495	3750 W	
595/650	4000 W	
Power Requirements		
395EU/490 1Ø, 50/60 Hz	110–120V, 12 A / 220–240V, 7 A	
495 1Ø, 50/60 Hz	110–120V, 15 A / 220–240V, 9 A	
595/650 1Ø, 50/60 Hz	110–120V, 15 A / 220–240V, 9 A	
<b>Dimensions</b>		
Height		
Stand	18.5 in.	47.0 cm
Lo-Boy (490/495/395EU/595)	22.5 in.	57.2 cm
Lo-Boy (650)	27.5 in.	70 cm
Hi-Boy	28.25 in. (Handle down) 38.25 in. (Handle up)	71.8 cm (Handle down) 97.2 cm (Handle up)
Length		
Stand	16 in.	40.6 cm
Lo-Boy (490/495/395EU/595)	26.5 in.	67.3 cm
Lo-Boy (650)	37 in.	94 cm
Hi-Boy	23.25 in.	59.1 cm

# Technical Specifications

490/495/595/650/395EU		
	US	Metric
<b>Width</b>		
Stand	14 in.	35.6 cm
Lo-Boy (490/495/395EU/595)	20 in.	50.6 cm
Lo-Boy (650)	22.5 in.	57 cm
Hi-Boy	20.5 in.	52.1 cm
<b>Weight</b>		
Stand		
395EU	45.1 lb.	20.5 kg
490 / 495	34 lb.	15 kg
Lo-Boy		
395EU	63 lb.	29 kg
490 / 495	59.1 lb.	26.8 kg
595	70 lb.	31.8 kg
650	77 lb.	34.9 kg
Hi-Boy		
395EU	66 lb.	30 kg
490 / 495	66.1 lb.	30 kg
595	73 lb.	33 kg
650	75 lb.	34 kg
<b>Noise** (dBa) @ 70 psi (0.48 MPa, 4.8 bar)</b>		
Sound pressure	90 dBa	
Sound power	100 dBa	
<b>Materials of Construction</b>		
Wetted materials on all models	zinc- and nickel-plated carbon steel, nylon, stainless steel, PTFE, acetal, leather, UHMWPE, aluminum, tungsten carbide, polyethylene, fluoroelastomer, urethane	
<b>Notes</b>		
* Startup pressures and displacement per cycle may vary based on suction condition, discharge head, air pressure, and fluid type.		
** Sound pressure measured 3 feet (1 meter) from equipment.		
Sound power measured per ISO-3744.		
All trademarks or registered trademarks are the property of their respective owners.		

## Compliance

### Radio Frequency Approvals

Transmitter Frequency (all models): 2.4GHz  
Transmitter Power (all models): +8dBm

**NOTE:** FCC/IC Notice (all models)  
Contains FCC ID: QOQBGM13P  
Contains IC: 5123A-BGM13P

The enclosed device complies with Part 15 of the FCC Rules and with Industry Canada license-exempt RSS standard(s). Operation is subject to the following two conditions:(1) this device may not cause harmful interference and (2) this device must accept any interference received, including interference that may cause undesired operation.

Changes or modifications not expressly approved by the party responsible for compliance could void the user's authority to operate the equipment.

This equipment is not granted protection against harmful interference and cannot cause interference on systems properly authorized.

This equipment has the board BGM13P22A with homologation code ANATEL 01330-19-03402.

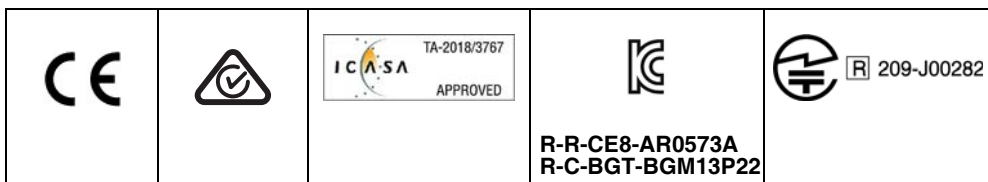

### CALIFORNIA PROPOSITION 65

 **WARNING:** This product can expose you to chemicals known to the State of California to cause cancer and birth defects or other reproductive harm. For more information go to [www.P65Warnings.ca.gov](http://www.P65Warnings.ca.gov).



## Graco Standard Warranty

Graco warrants all equipment referenced in this document which is manufactured by Graco and bearing its name to be free from defects in material and workmanship on the date of sale to the original purchaser for use. With the exception of any special, extended, or limited warranty published by Graco, Graco will, for a period of twelve months from the date of sale, repair or replace any part of the equipment determined by Graco to be defective. This warranty applies only when the equipment is installed, operated and maintained in accordance with Graco's written recommendations.

This warranty does not cover, and Graco shall not be liable for general wear and tear, or any malfunction, damage or wear caused by faulty installation, misapplication, abrasion, corrosion, inadequate or improper maintenance, negligence, accident, tampering, or substitution of non-Graco component parts. Nor shall Graco be liable for malfunction, damage or wear caused by the incompatibility of Graco equipment with structures, accessories, equipment or materials not supplied by Graco, or the improper design, manufacture, installation, operation or maintenance of structures, accessories, equipment or materials not supplied by Graco.

This warranty is conditioned upon the prepaid return of the equipment claimed to be defective to an authorized Graco distributor for verification of the claimed defect. If the claimed defect is verified, Graco will repair or replace free of charge any defective parts. The equipment will be returned to the original purchaser transportation prepaid. If inspection of the equipment does not disclose any defect in material or workmanship, repairs will be made at a reasonable charge, which charges may include the costs of parts, labor, and transportation.

**THIS WARRANTY IS EXCLUSIVE, AND IS IN LIEU OF ANY OTHER WARRANTIES, EXPRESS OR IMPLIED, INCLUDING BUT NOT LIMITED TO WARRANTY OF MERCHANTABILITY OR WARRANTY OF FITNESS FOR A PARTICULAR PURPOSE.**

Graco's sole obligation and buyer's sole remedy for any breach of warranty shall be as set forth above. The buyer agrees that no other remedy (including, but not limited to, incidental or consequential damages for lost profits, lost sales, injury to person or property, or any other incidental or consequential loss) shall be available. Any action for breach of warranty must be brought within two (2) years of the date of sale.

**GRACO MAKES NO WARRANTY, AND DISCLAIMS ALL IMPLIED WARRANTIES OF MERCHANTABILITY AND FITNESS FOR A PARTICULAR PURPOSE, IN CONNECTION WITH ACCESSORIES, EQUIPMENT, MATERIALS OR COMPONENTS SOLD BUT NOT MANUFACTURED BY GRACO.** These items sold, but not manufactured by Graco (such as electric motors, switches, hose, etc.), are subject to the warranty, if any, of their manufacturer. Graco will provide purchaser with reasonable assistance in making any claim for breach of these warranties.

In no event will Graco be liable for indirect, incidental, special or consequential damages resulting from Graco supplying equipment hereunder, or the furnishing, performance, or use of any products or other goods sold hereto, whether due to a breach of contract, breach of warranty, the negligence of Graco, or otherwise.

### **FOR GRACO CANADA CUSTOMERS**

The Parties acknowledge that they have required that the present document, as well as all documents, notices and legal proceedings entered into, given or instituted pursuant hereto or relating directly or indirectly hereto, be drawn up in English. Les parties reconnaissent avoir convenu que la rédaction du présente document sera en Anglais, ainsi que tous documents, avis et procédures judiciaires exécutés, donnés ou intentés, à la suite de ou en rapport, directement ou indirectement, avec les procédures concernées.

## **Graco Information**

For the latest information about Graco products, visit [www.graco.com](http://www.graco.com).

For patent information, see [www.graco.com/patents](http://www.graco.com/patents).

**TO PLACE AN ORDER**, contact your Graco distributor or call 1-800-690-2894 to identify the nearest distributor.





*All written and visual data contained in this document reflects the latest product information available at the time of publication.*

*Graco reserves the right to make changes at any time without notice.*

Original instructions. This manual contains English. MM 3A6491

**Graco Headquarters:** Minneapolis

**International Offices:** Belgium, China, Japan, Korea

**GRACO INC. AND SUBSIDIARIES • P.O. BOX 1441 • MINNEAPOLIS MN 55440-1441 • USA**

**Copyright 2018, Graco Inc. All Graco manufacturing locations are registered to ISO 9001.**

www.graco.com  
Revision H, July 2020